

VOLKSWAGEN

AKTIENGESELLSCHAFT

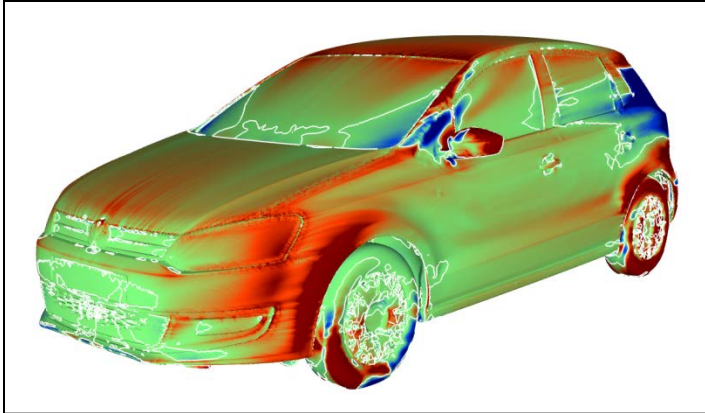

Symposium in Honor of Antony Jameson's 80th Birthday,
Stanford University 2014

The Adjoint Method Hits the Road: Applications in Car Aerodynamics

Dr. Carsten Othmer, Volkswagen AG, Corporate Research, Wolfsburg, Germany

Adjoint-Based Optimization for Cars: Overview

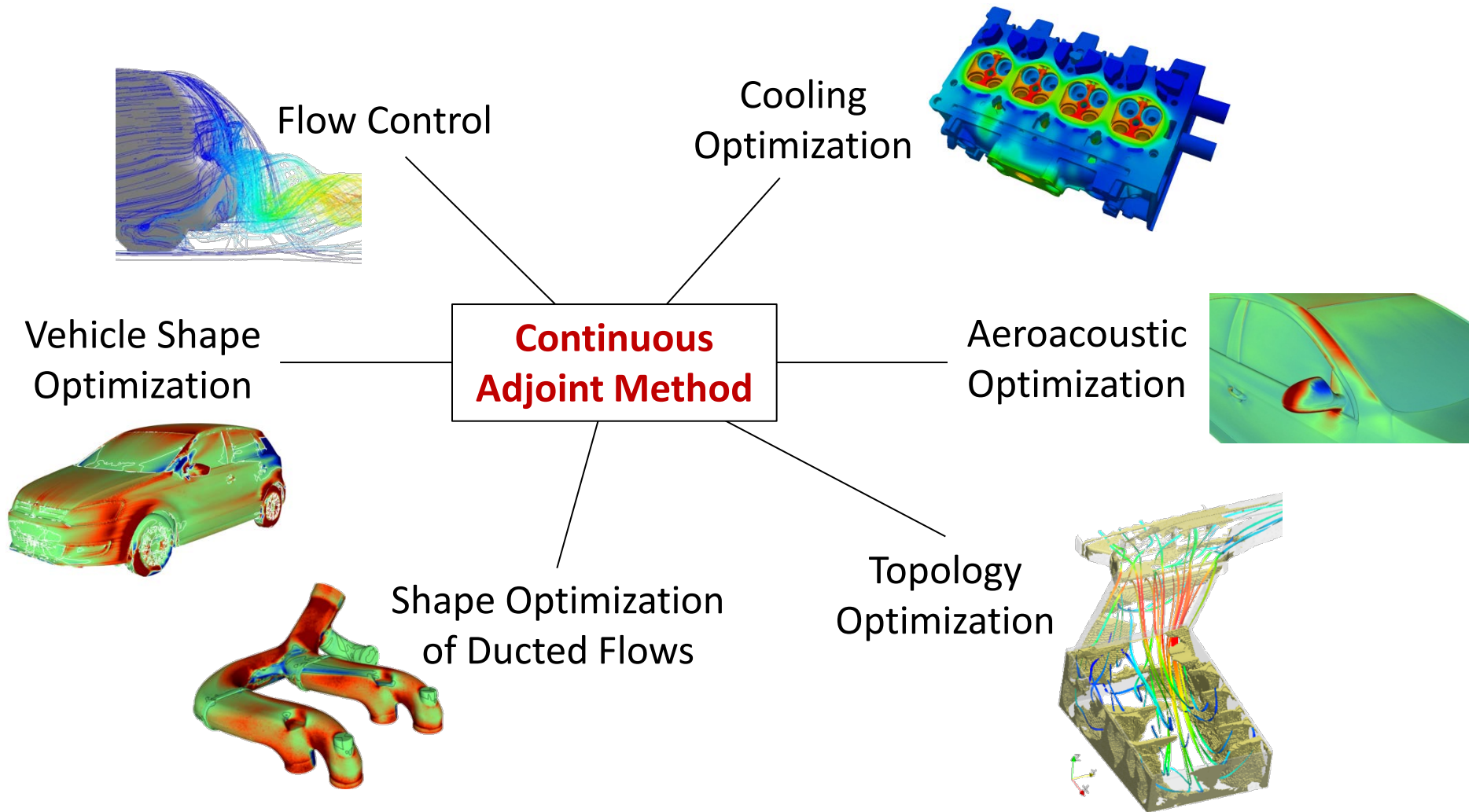

Acknowledgements

- Prof. Giannakoglou's team at the National Technical University of Athens



- Eugene De Villiers and Thomas Schumacher from Engys, London



- E. Stavropoulou, M. Hojjat and Prof. Bletzinger from TU Munich



- The Adjoint team at Volkswagen: S. Baumbach, K. Brandes, M. Gregersen, F. Kunze, N. Magoulas, J. Müller, H. Narten, D. Schröder and other supportive colleagues

The Adjoint Method: Computation of Sensitivity Maps

Surface Sensitivities = $\partial J / \partial \beta$

red: push away from the fluid

blue: push towards the fluid

Massflow

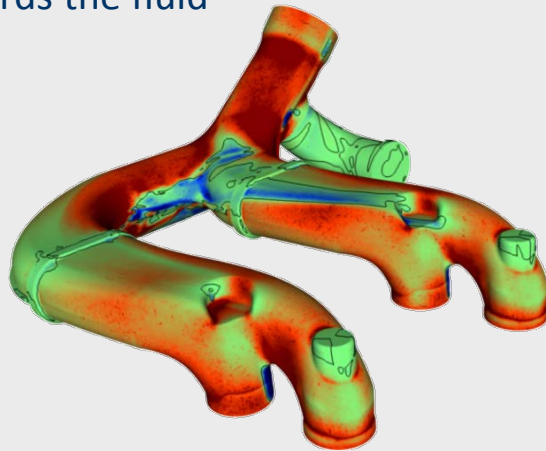

Drag

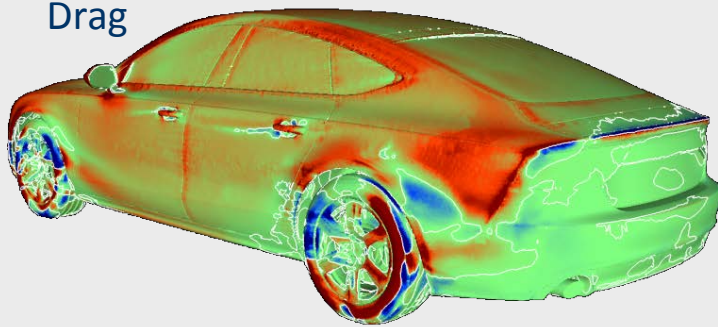

Volume Sensitivities = $\partial J / \partial \alpha$

red: important areas

blue: counterproductive areas

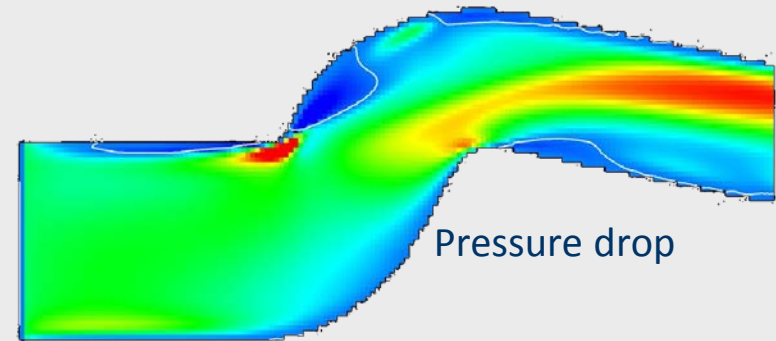

Pressure drop

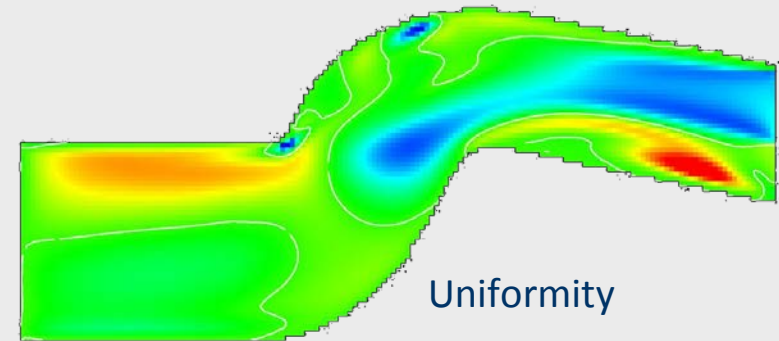

Uniformity

The Adjoint Method: Computational Process

1. CFD computation: \underline{v} , p (“primal field“)

$$\begin{aligned}(\mathbf{v} \cdot \nabla) \mathbf{v} &= -\nabla p + \nabla \cdot (\nu \nabla \mathbf{v}) - \alpha \mathbf{v} \\ \nabla \cdot \mathbf{v} &= 0\end{aligned}$$

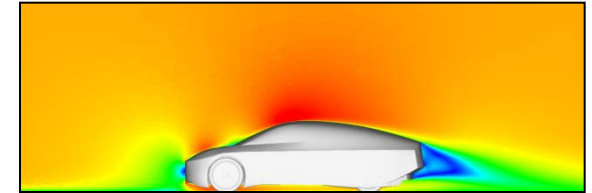

2. Adjoint CFD computation: \underline{u} , q (“dual field“)

$$\begin{aligned}-\left(\nabla \mathbf{u}\right) \mathbf{v} - \left(\mathbf{v} \cdot \nabla\right) \mathbf{u} &= -\nabla q + \nabla \cdot (\nu \nabla \mathbf{u}) - \alpha \mathbf{u} \\ \nabla \cdot \mathbf{u} &= 0\end{aligned}$$

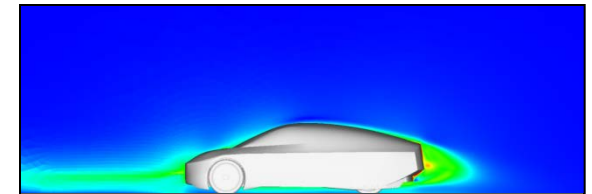

3. Computation of sensitivities:

- Volume sensitivities: $\frac{\partial J}{\partial \alpha} \sim \mathbf{v} \cdot \mathbf{u}$
- Surface sensitivities: $\frac{\partial J}{\partial \beta} \sim \frac{\partial \mathbf{v}}{\partial n} \cdot \frac{\partial \mathbf{u}}{\partial n}$

Implementation of an Adjoint Solver for Automotive Applications

- Platform: Open source code OpenFOAM® chosen in 2006

```
solve ( fvm::ddt(rho, U) + fvm::div(phi, U) - fvm::laplacian(mu, U)
        == - fvc::grad(p) );
```

- Topology optimization [VW, AIAA 2007]
- Shape sensitivities [VW, IJNMF 2008]
- Low-Re Adjoint turbulence [NTUA + VW, C&F 2009]
- Adjoint wall functions [NTUA + VW, JCP 2010, ECCOMAS 2014]
- Packaging and further industrialization by Engys [since 2011]
- Uptake and improvements by Helgason, Hinterberger, Jakubek, Lincke, Towara, ...

→ Versatile continuous adjoint solver “adjointFoam” for incompressible steady-state RANS

Adjoint-Based Optimization for Cars: Overview

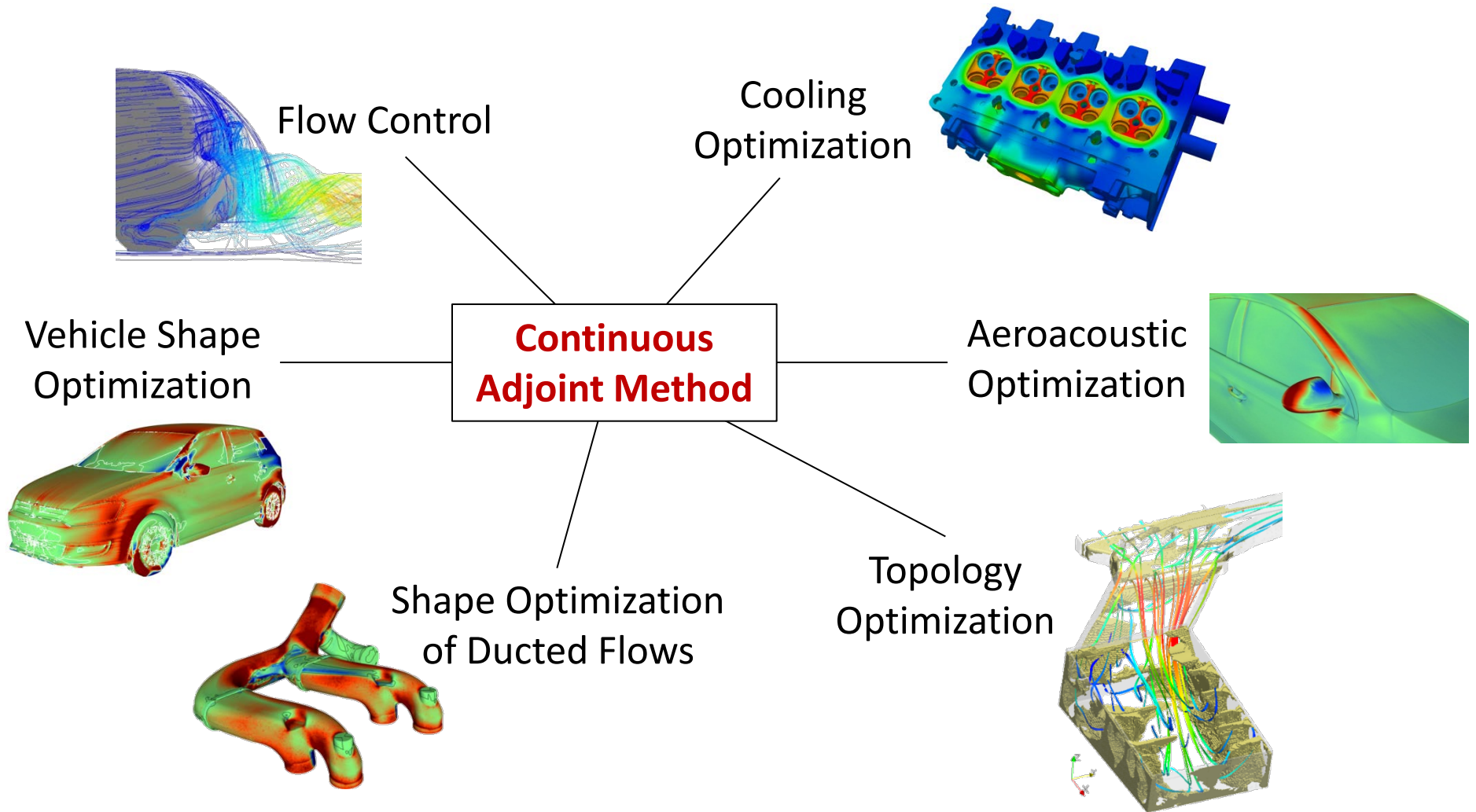

Topology Optimization

- Well-developed tool in **structure** mechanics, wide-spread industrial use

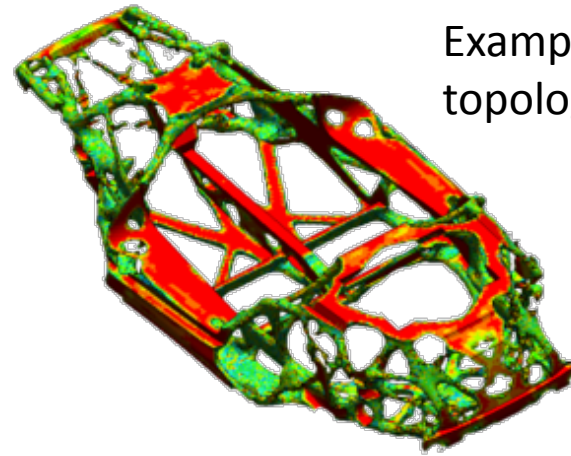
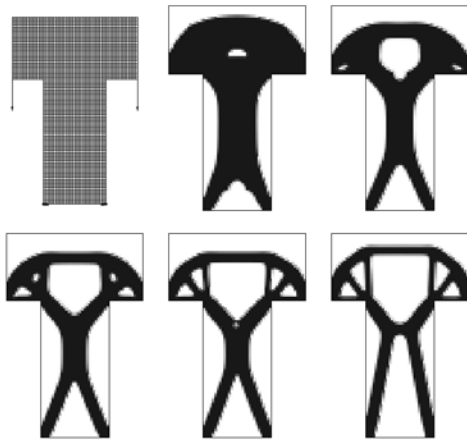

Example: Optimal car body topology [Conic, VW]

- Transfer to **fluid** dynamics: Klimetzek [Daimler, 2003], Borrvall and Petersson [2003]

Topology Optimization for Fluid Dynamics

- Starting point: **Entire installation space**

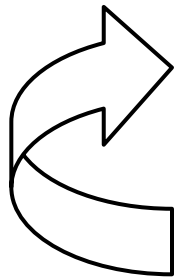

- Flow solution
- Identification of “counter-productive” cells via a **local criterion** ($\underline{v} \cdot \underline{u}$)
- Punishment of counter-productive cells with porosity

- Result: Optimal topology

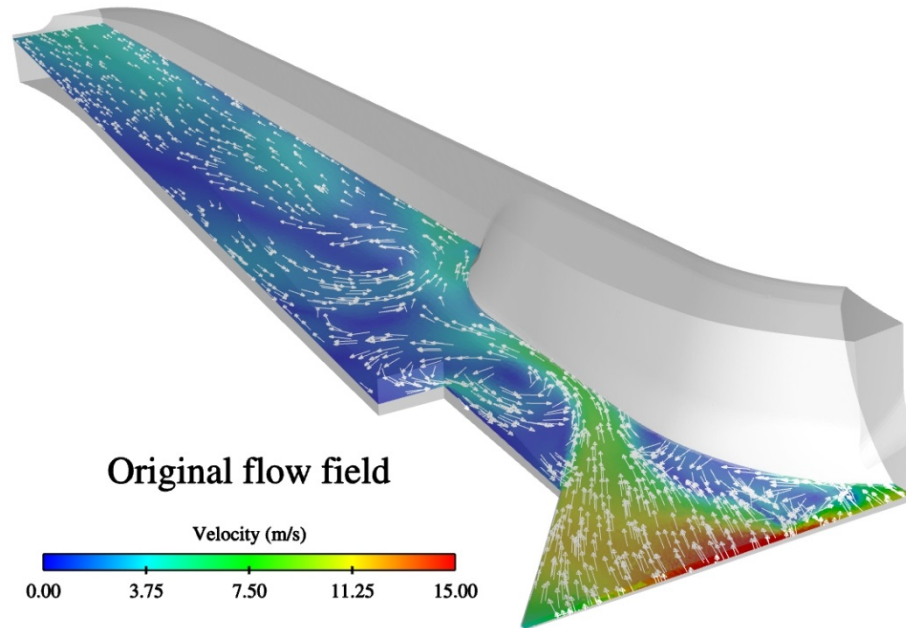

Topology Optimization for Fluid Dynamics

- Starting point: **Entire installation space**

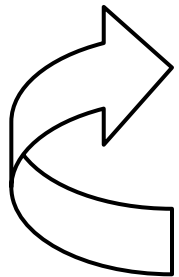

- Flow solution
- Identification of “counter-productive” cells via a **local criterion** ($\underline{v} \cdot \underline{u}$)
- Punishment of counter-productive cells with porosity

- Result: Optimal topology

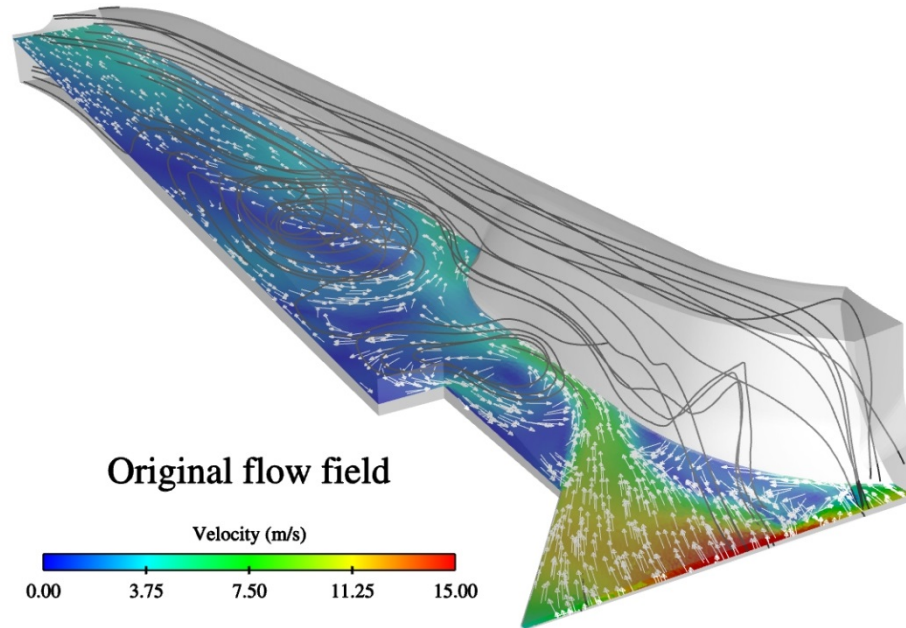

Topology Optimization for Fluid Dynamics

- Starting point: **Entire installation space**

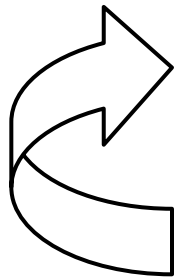

- Flow solution
- Identification of “counter-productive” cells via a **local criterion** ($\underline{v} \cdot \underline{u}$)
- Punishment of counter-productive cells with porosity

- Result: Optimal topology

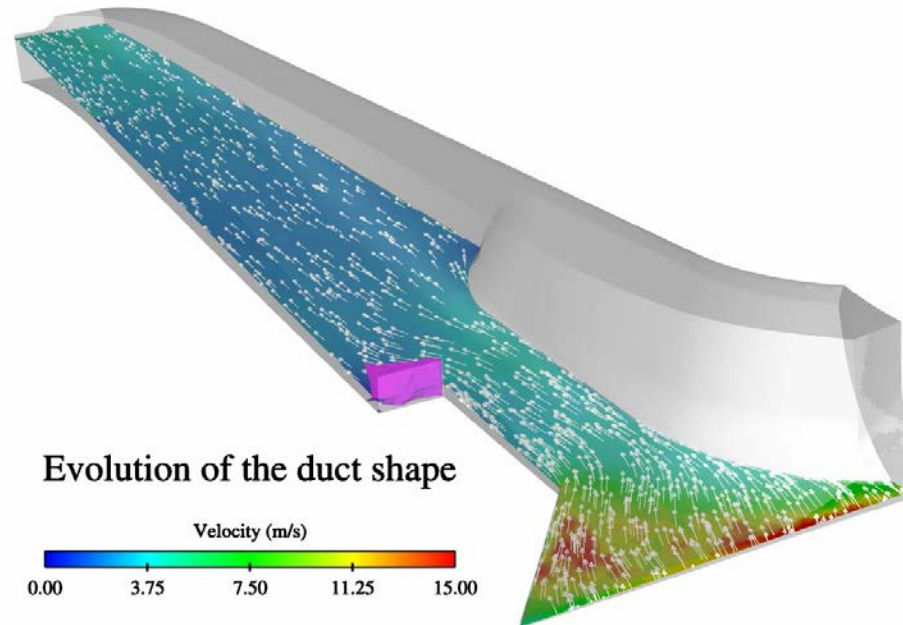

Topology Optimization for Fluid Dynamics

- Starting point: **Entire installation space**

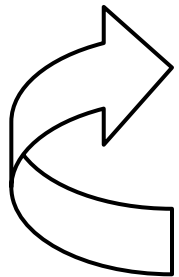

- Flow solution
- Identification of “counter-productive” cells via a **local criterion** ($\underline{v} \cdot \underline{u}$)
- Punishment of counter-productive cells with porosity

- Result: Optimal topology

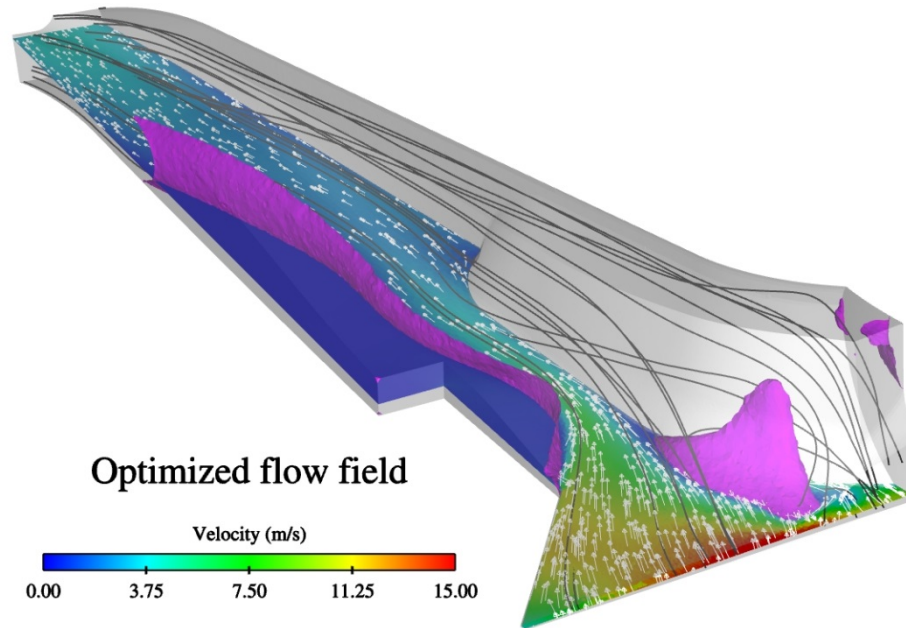

Topo Example 1: From Packaging Space to the Optimal Port

Packaging space definition

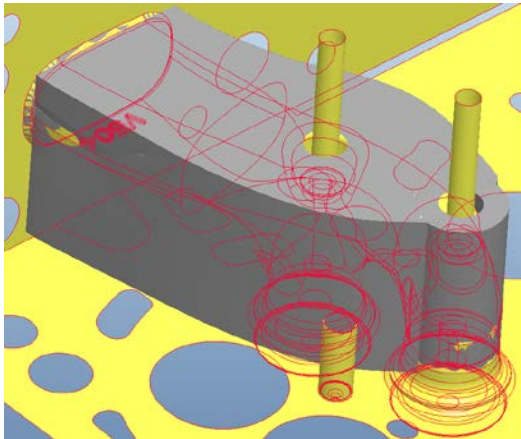

[F. Kunze and R. Niederlein]

Drafting with adjointFoam

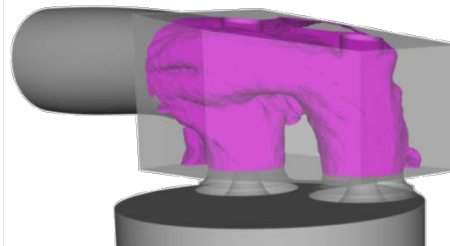

adjointFoam + manual CAD iterations



Fine-tuning with adjointFoam

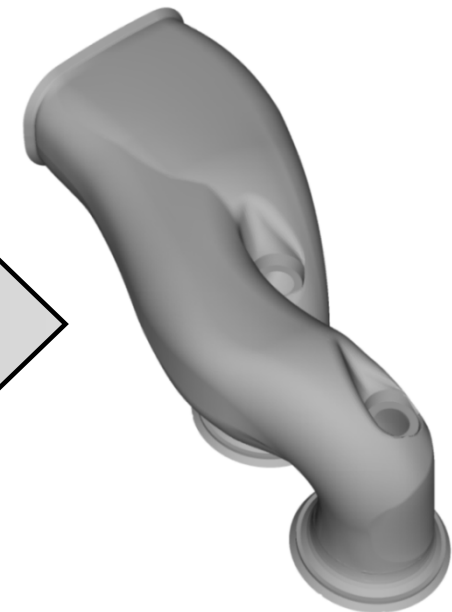

Final (hand-made) CAD geometry

Topo Example 2: Multi-Objective Intake Port Optimization

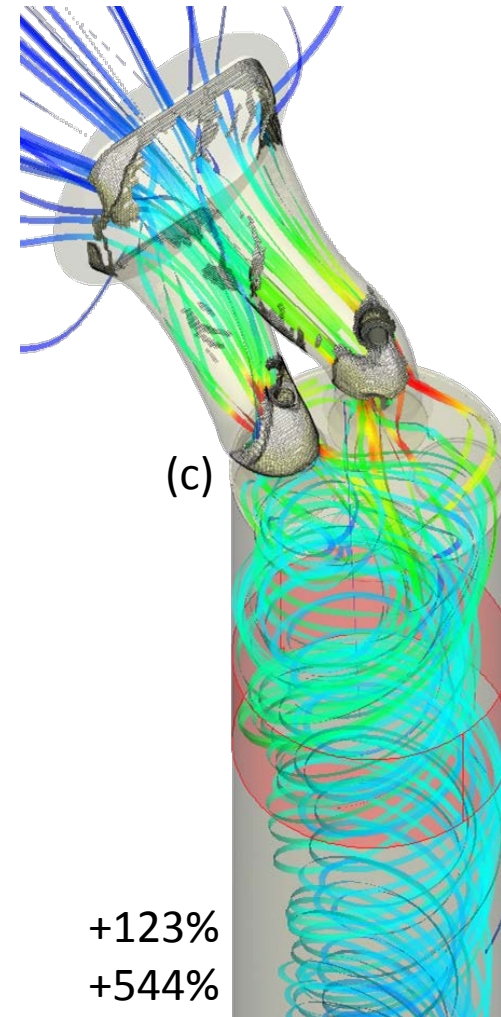
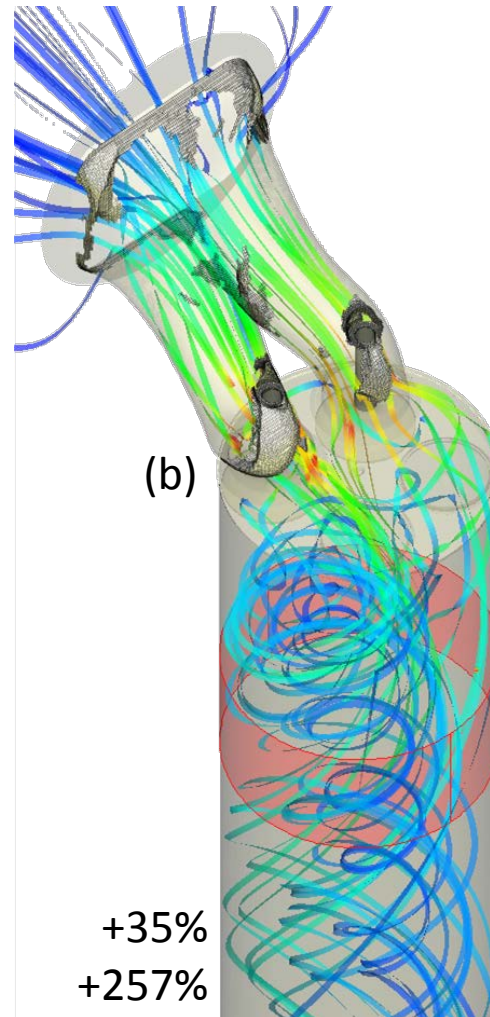
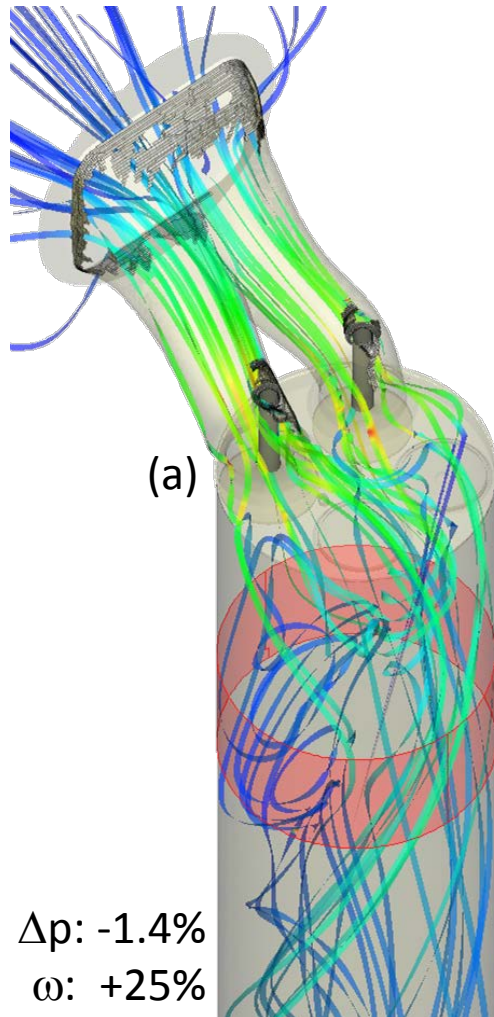

CFD Topology Optimization: Application Spectrum

[F. Kunze,
U. Giffhorn]

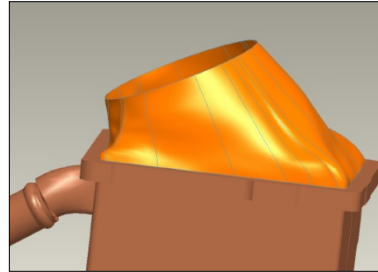
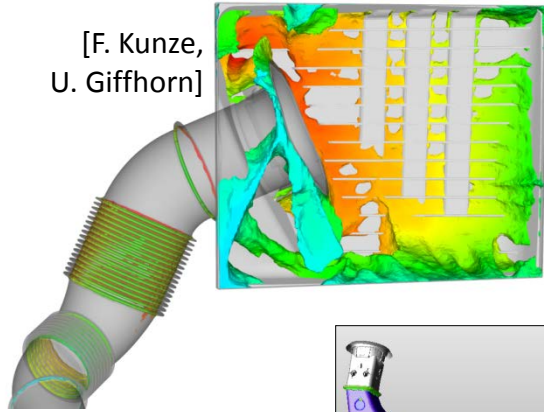

[M. Tomecki]

[U. Giffhorn]

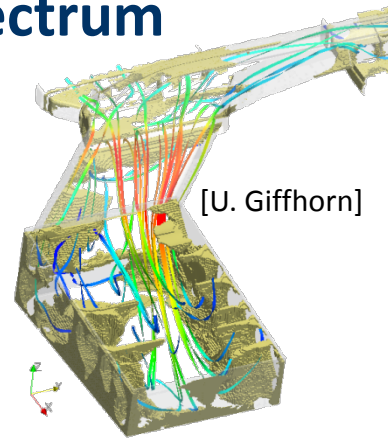

[R. Niederlein]

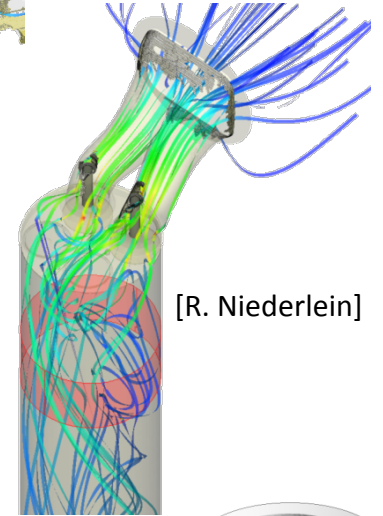

[N. Peller]

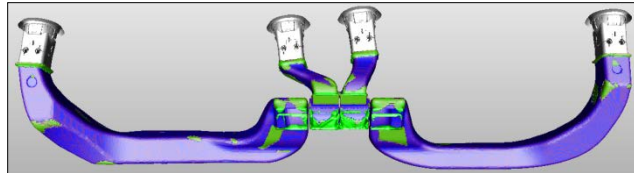

[C. Ehlers, K. Arntz]

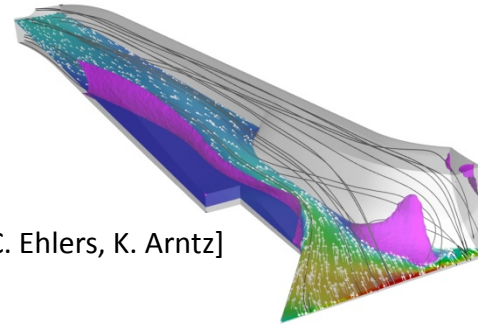

[U. Giffhorn]

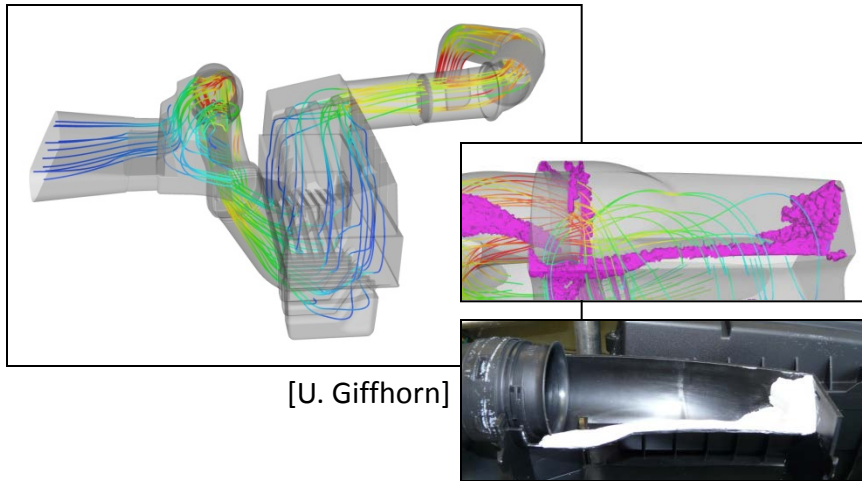

[P. Unterlechner]

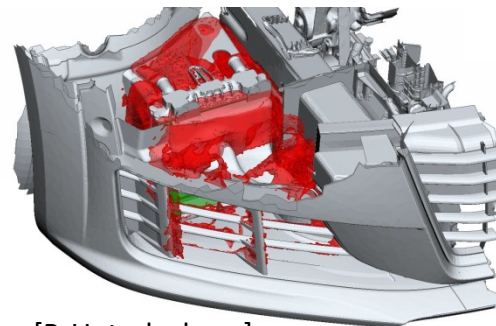

[M. Towara]

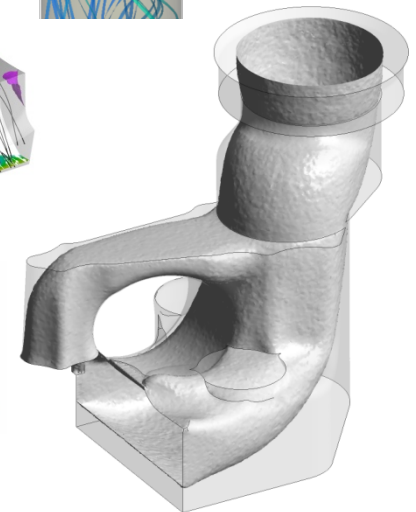

Shape Optimization for Ducted Flows: Exhaust Port Example

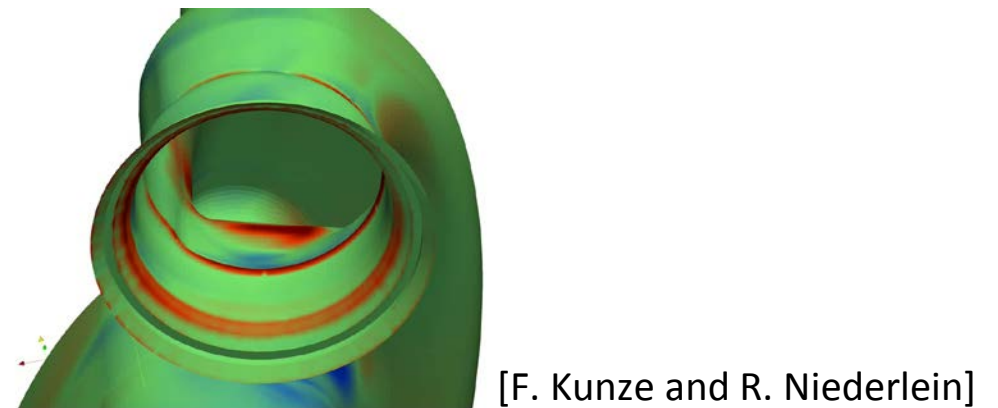
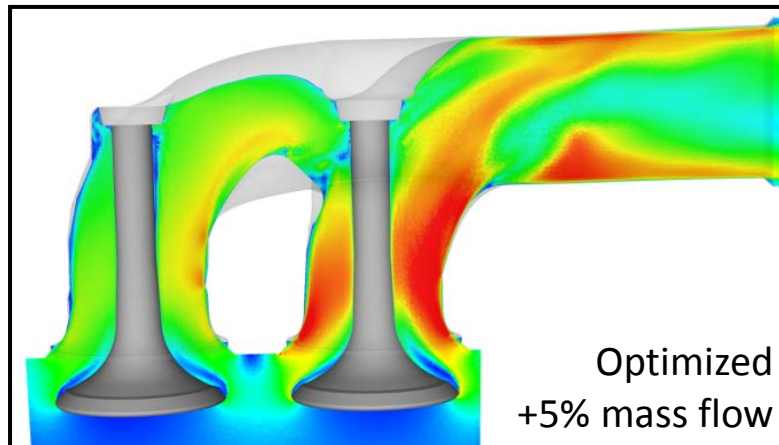
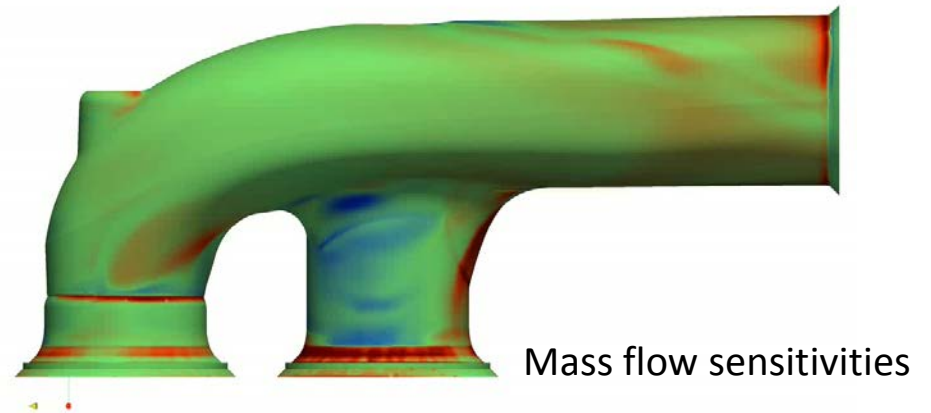
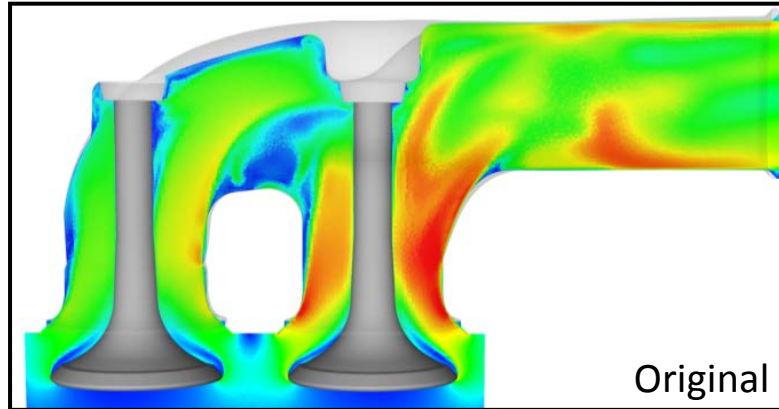

Adjoint-Based Optimization for Cars: Overview

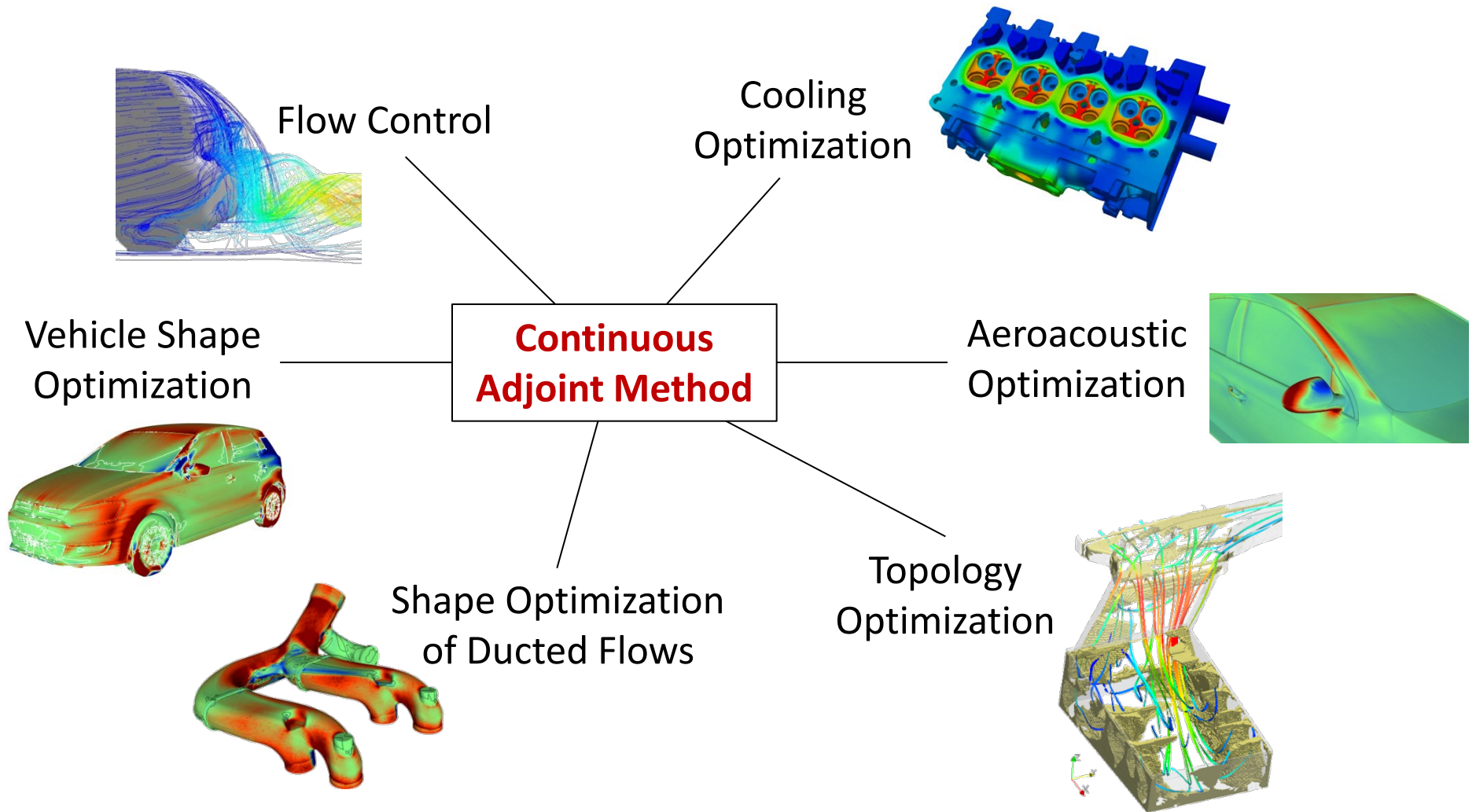

Shape Optimization in External Aerodynamics: Example 1

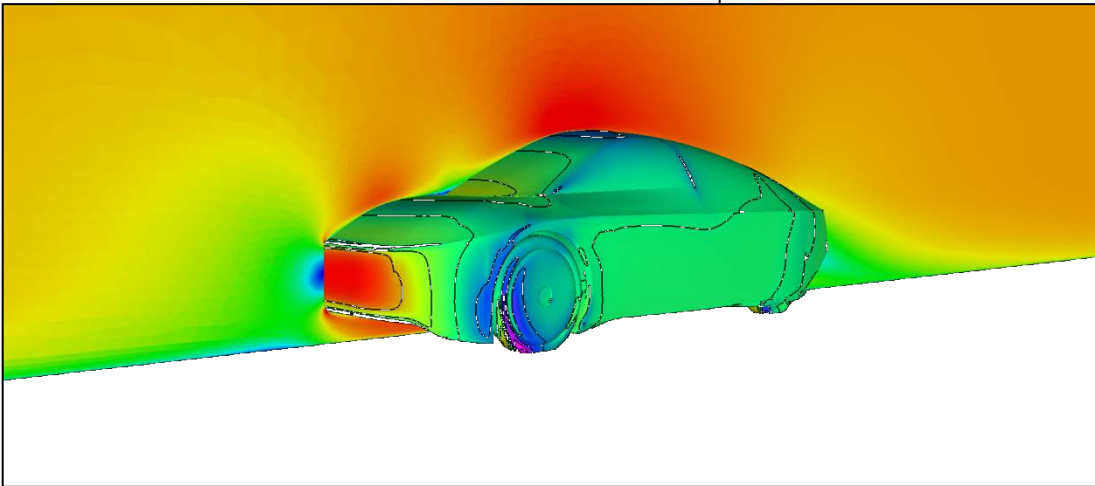
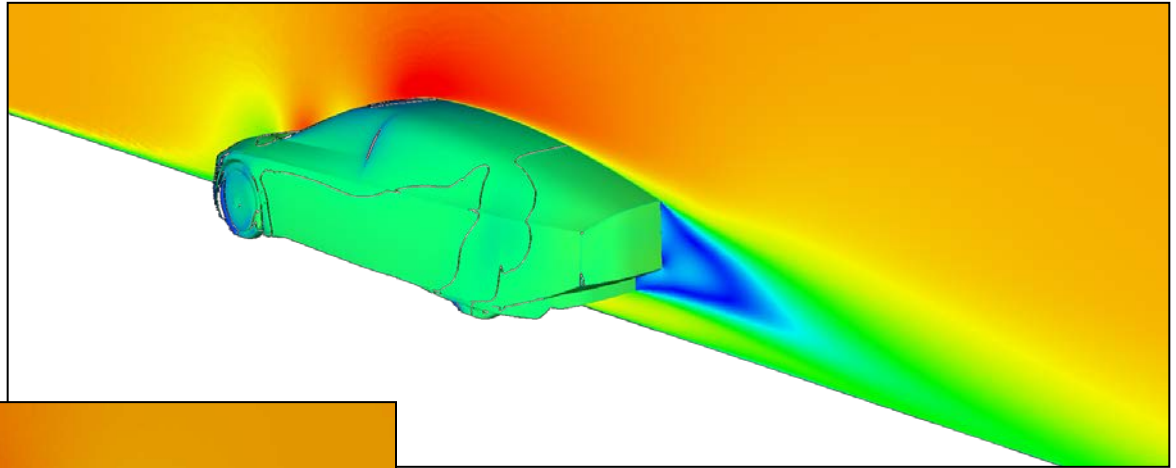

- Volkswagen XL1
- $v=33\text{m/s}$
- RANS with Spalart-Allmaras
- low-Reynolds mesh ($y^+ \sim 1$)
- half-model

Volkswagen XL1: Sensitivities (1)

red: inwards for smaller drag

blue: outwards

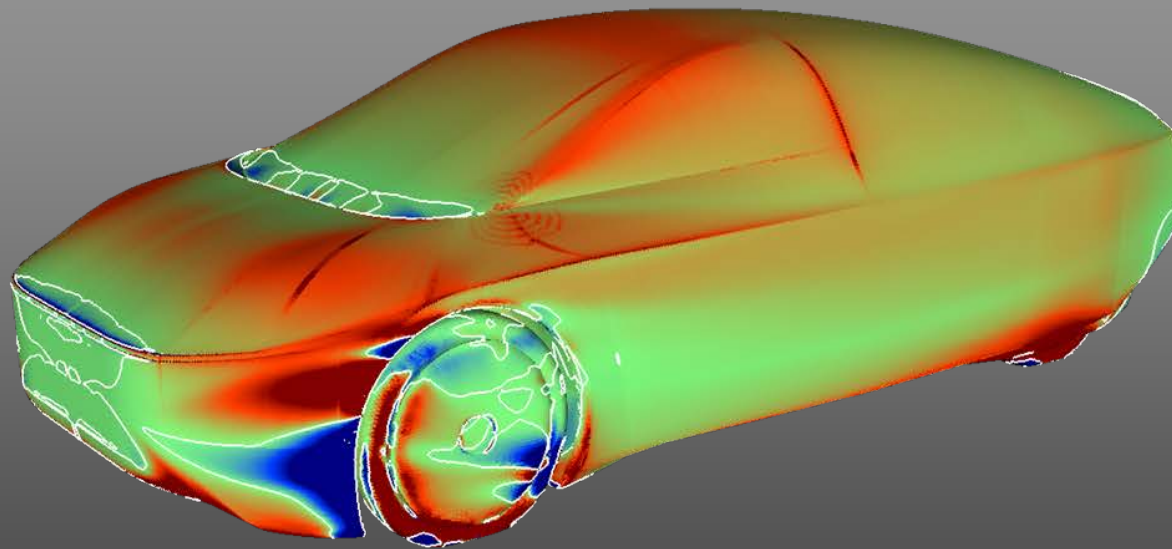

Surface Sensitivity (N/m^3)

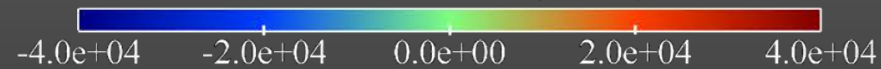

Volkswagen XL1: Sensitivities (2)

red: inwards for smaller drag
blue: outwards

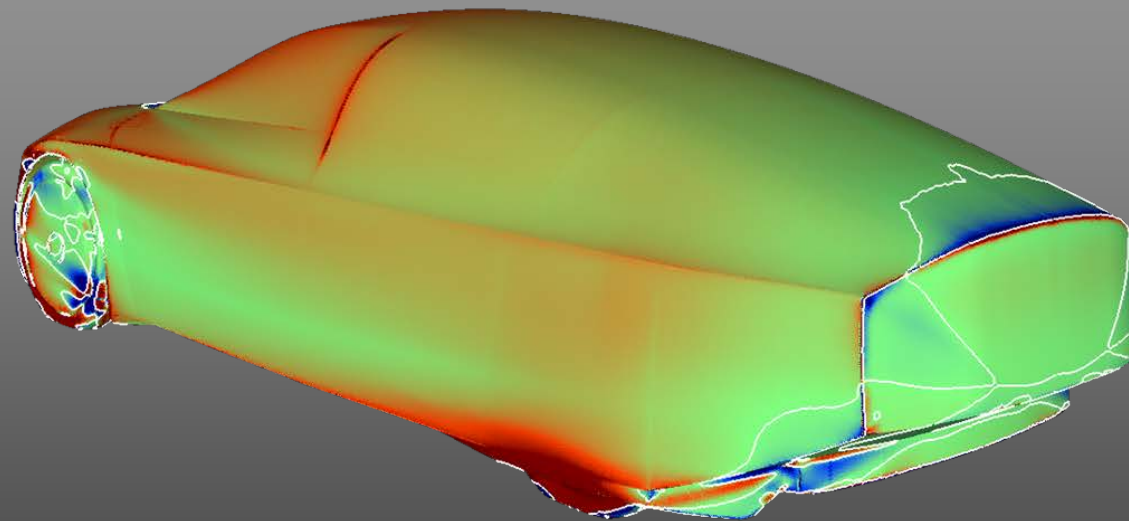

Surface Sensitivity (N/m^3)

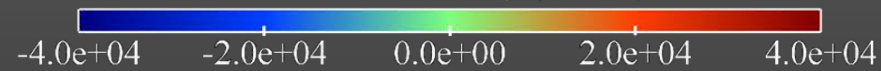

One-Shot Optimization of the Rear Spoiler

- 5 free-form-deformation control points defined to control rear edge
- Variation in the z-direction only → 5 design variables
- Objective function: Drag

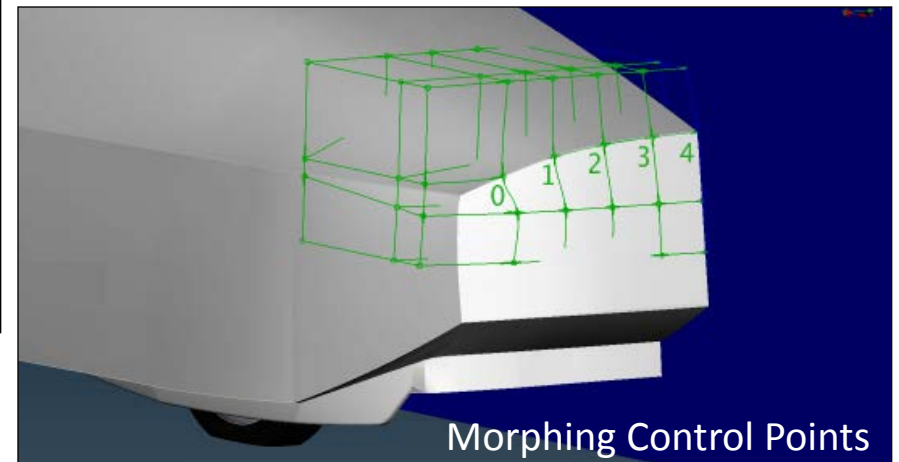
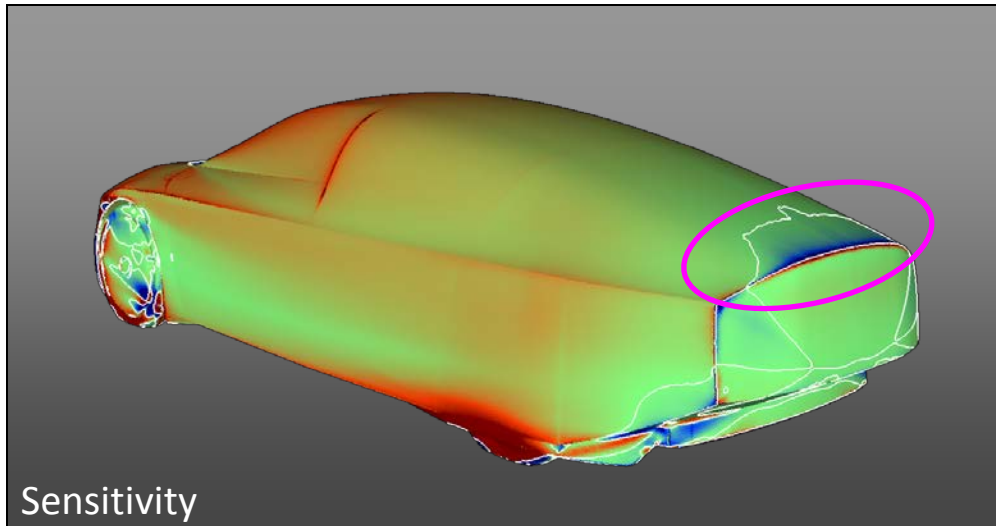

Optimization Results

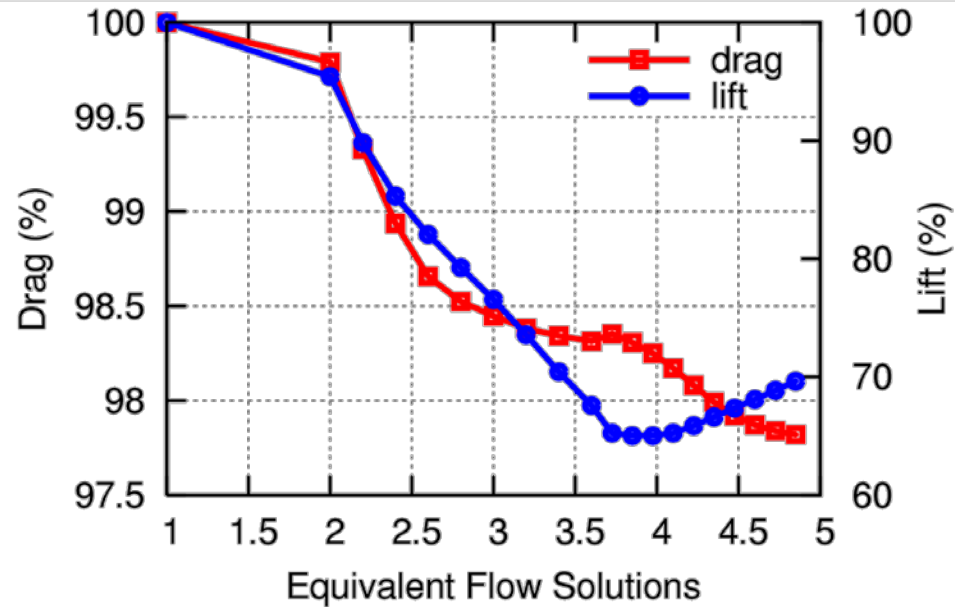

- >2% drag reduction, 30% lift improvement
- Deformation in z-direction < 20mm
- Overall cost: <5 EFS

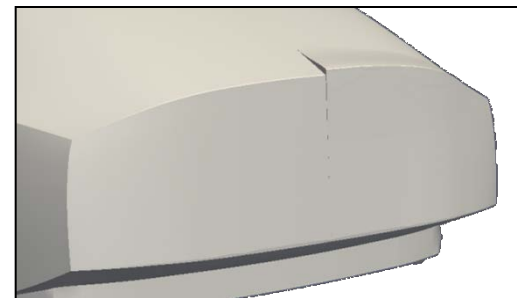

Shape Optimization in External Aerodynamics: Example 2

- External mirror shape optimization w.r.t. total vehicle drag
- Sensitivities by adjointFoam, morphing with Carat (TU Munich)

Sensitivity

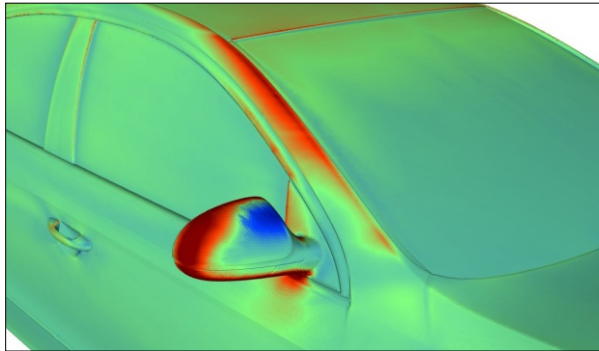

Displacement

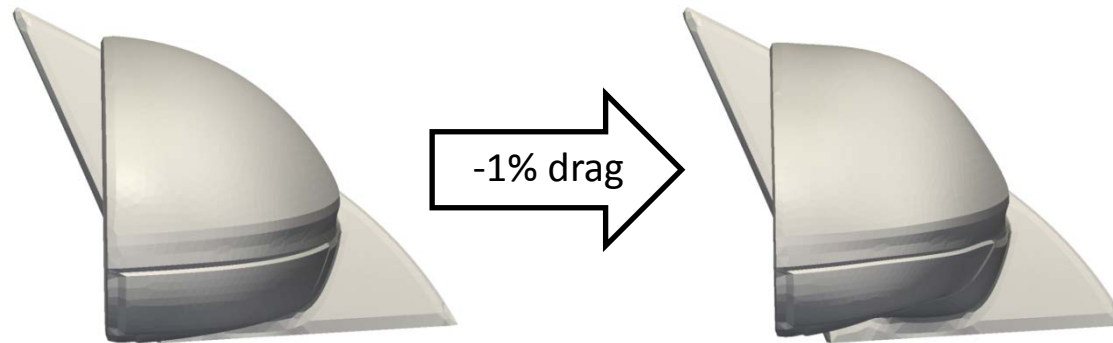
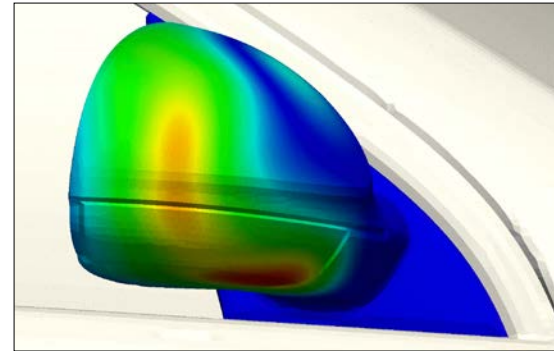

- Conservation of feature lines is an essential ingredient for external aero optimization

Productive Aerodynamics Computations: DES instead of RANS

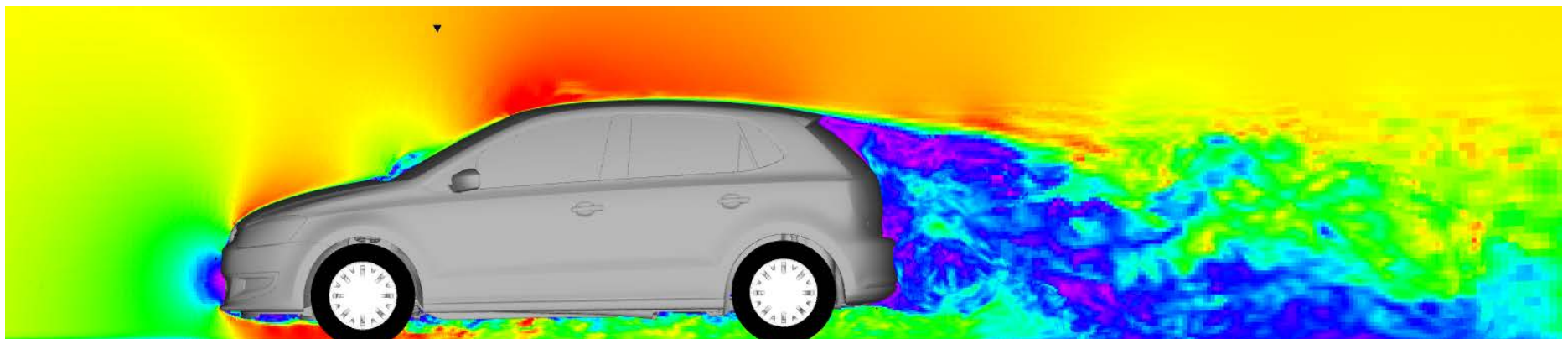
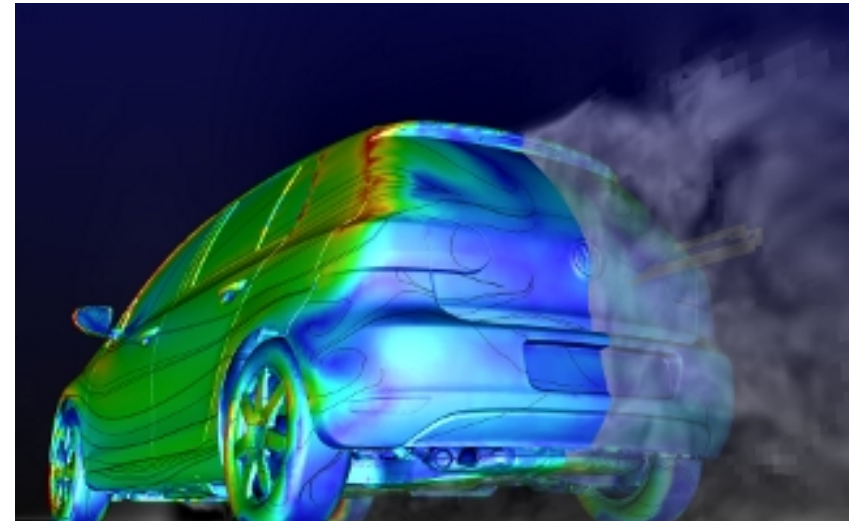
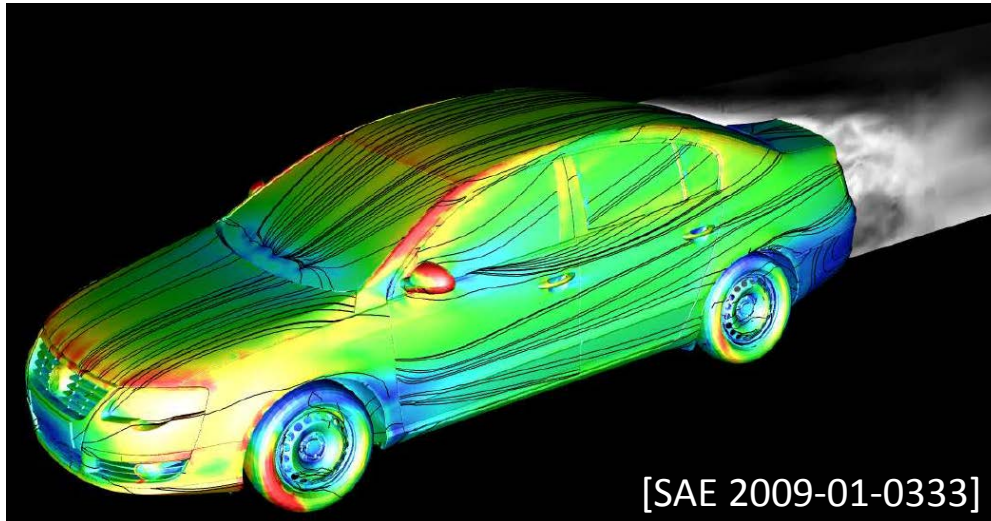

Approximate DES-Based Sensitivities

1. Basis: Time-averaged primal DES, compute drag and lift coefficients
 2. Take time-averaged primal velocity and solve for a RANS- ν_t
 3. Run adjoint RANS with averaged primal velocity and ν_t
-
- Finite differences: far off, *qualitative* agreement only

RANS vs. DES: Case Study Audi A7



RANS vs. DES: Drag Sensitivities Audi A7

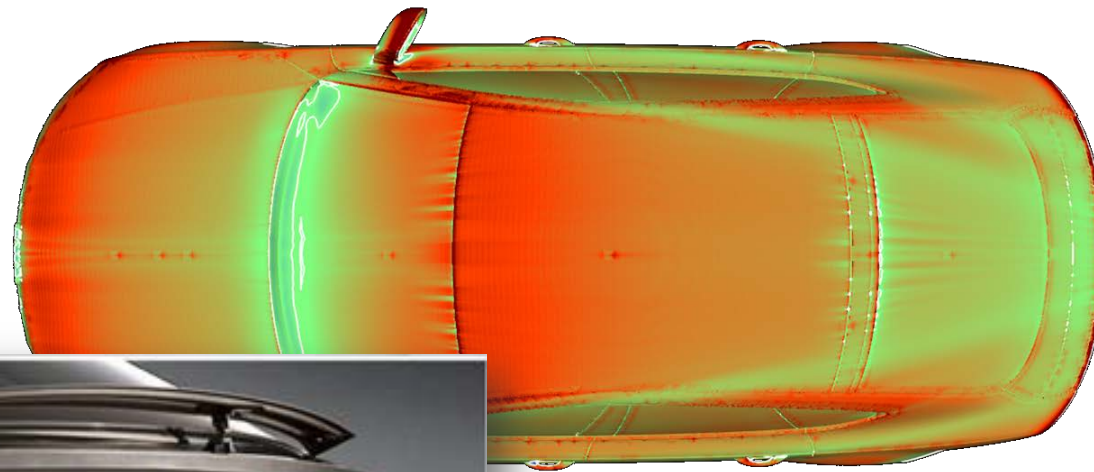

RANS

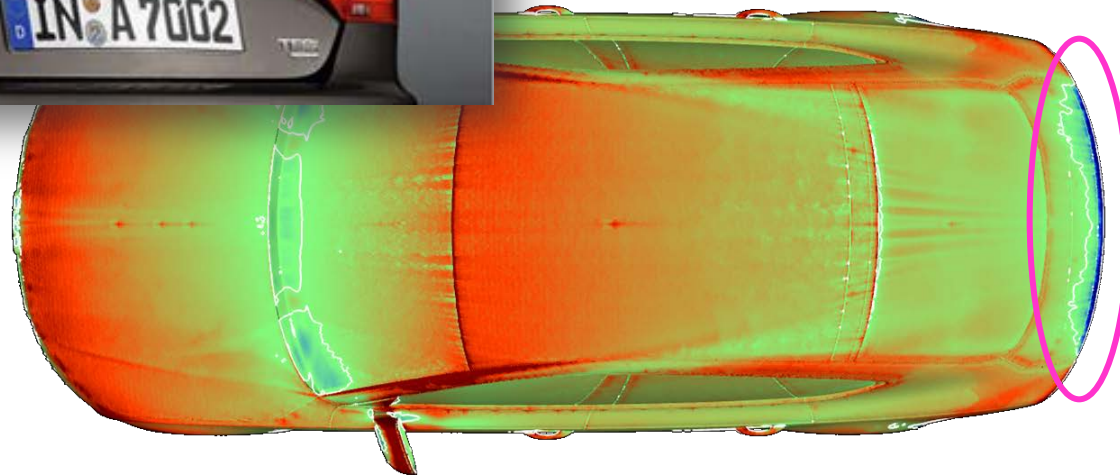

DES

RANS vs. DES: Drag Sensitivities Audi A7

RANS

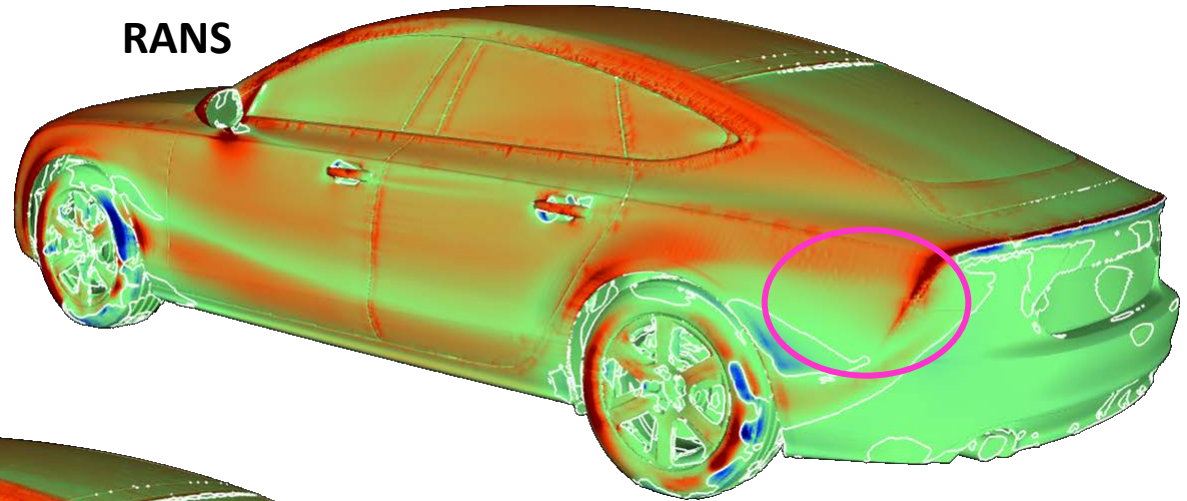

DES

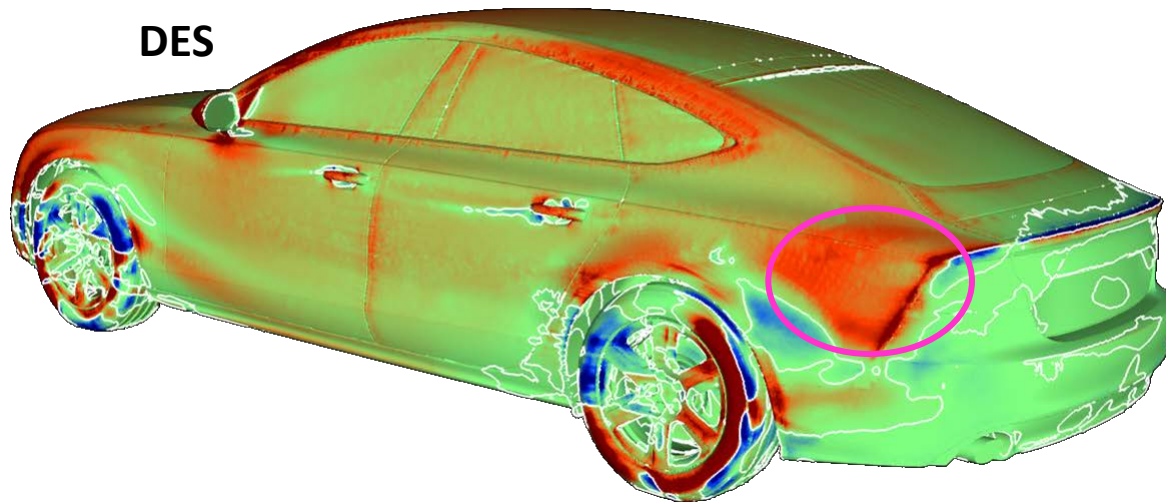

Productive effect of
boat-tailing verified in
wind tunnel tests

Drag Sensitivity Maps Based on DES: Further Examples

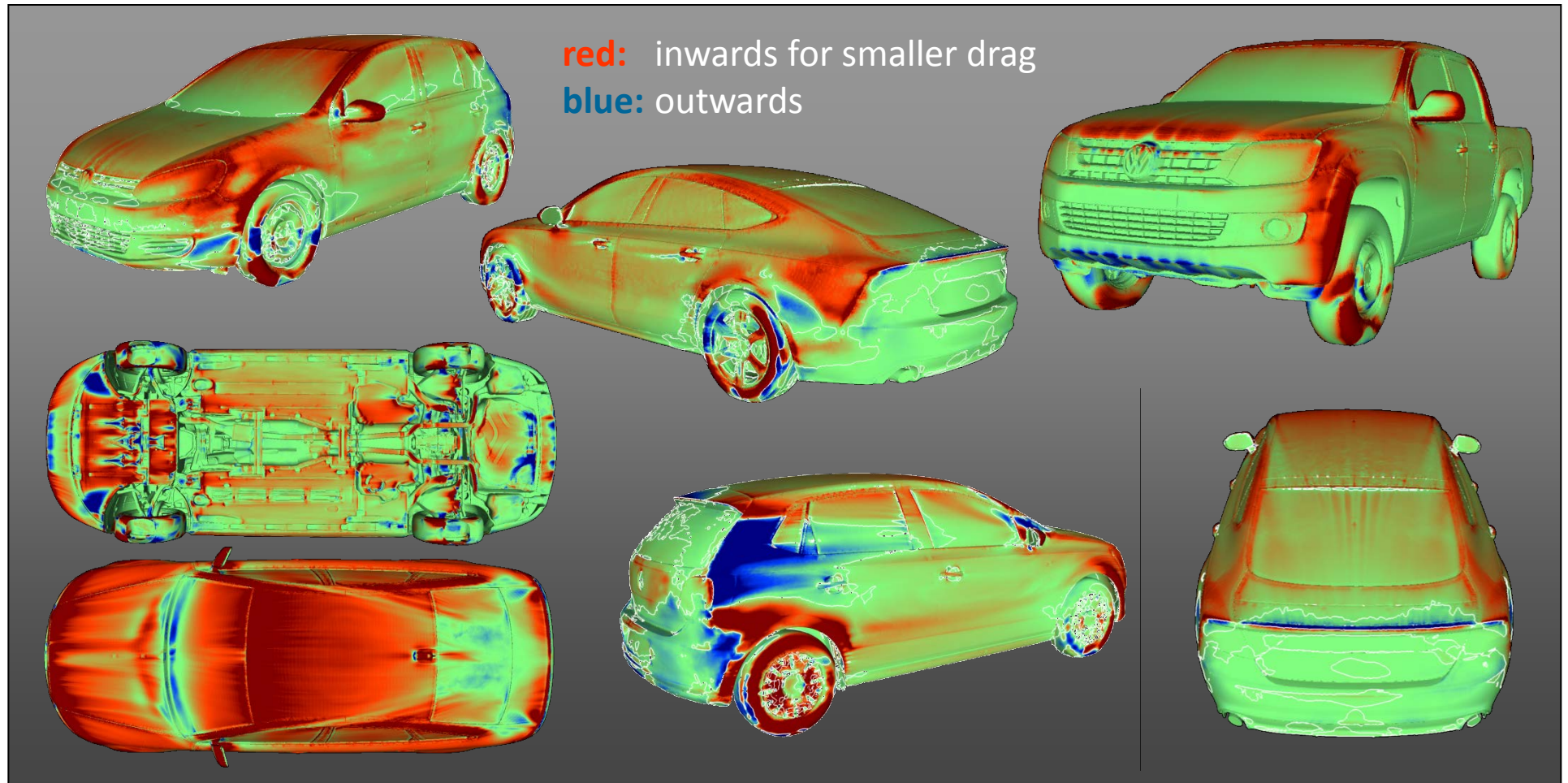

Adjoint-Based Optimization for Cars: Overview

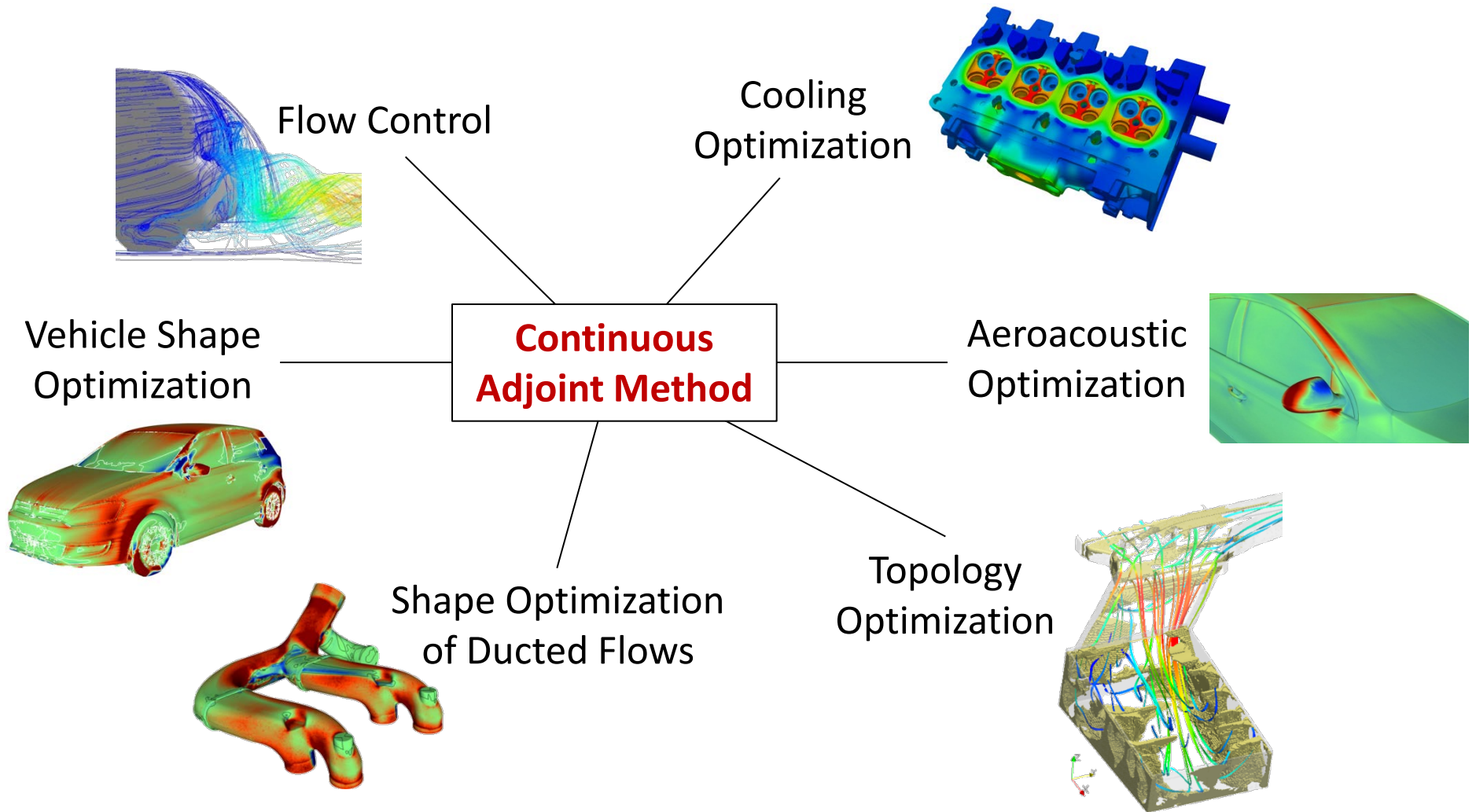

Case Study Volkswagen XL1: Drag Sensitivities

Sensitivity Map of dF_x/dv_n , with v_n : blowing/suction velocity

blue: blowing favourable

red: suction favourable

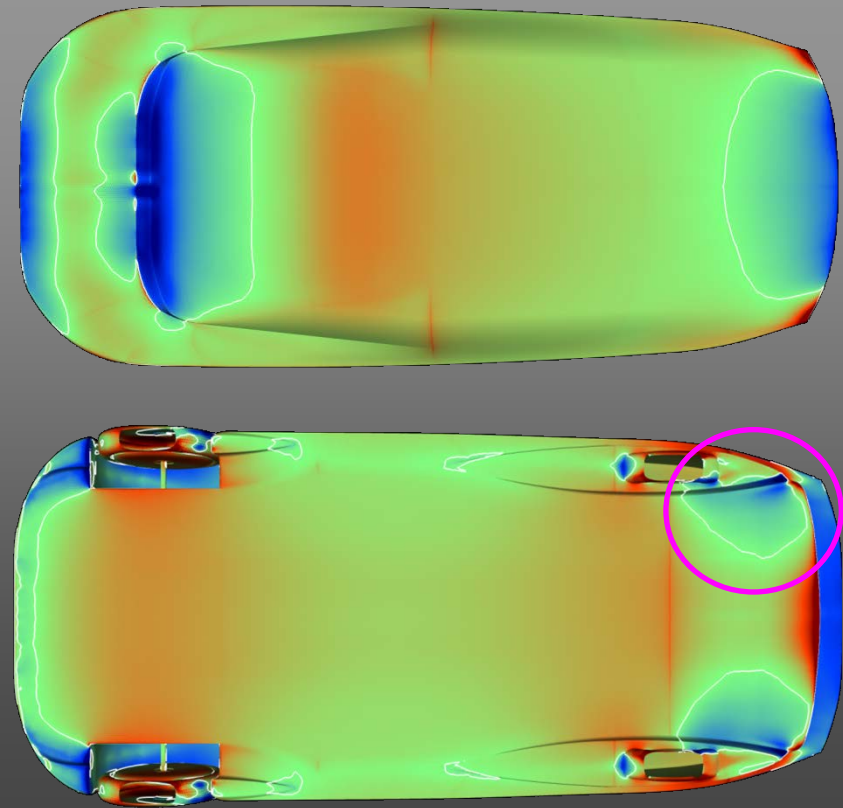
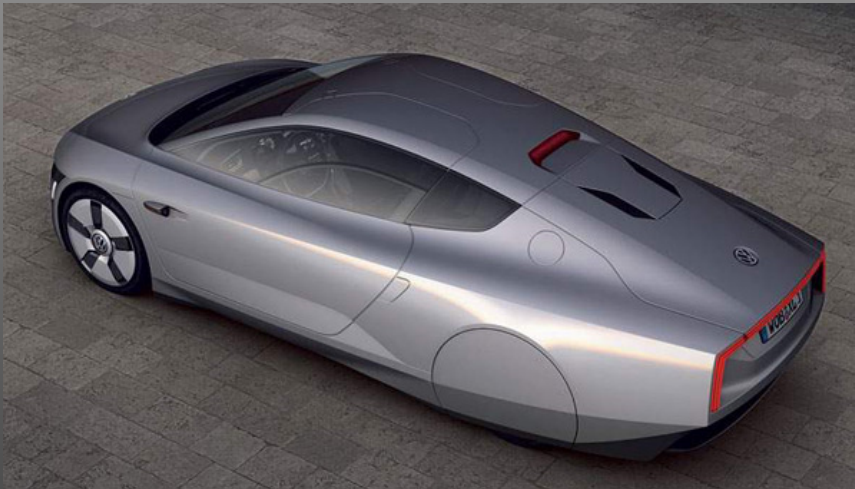

Wind Tunnel Measurements on a 1:4 Model

- Placement of blowing jets on the rear underbody
- Cooperation with TU Braunschweig

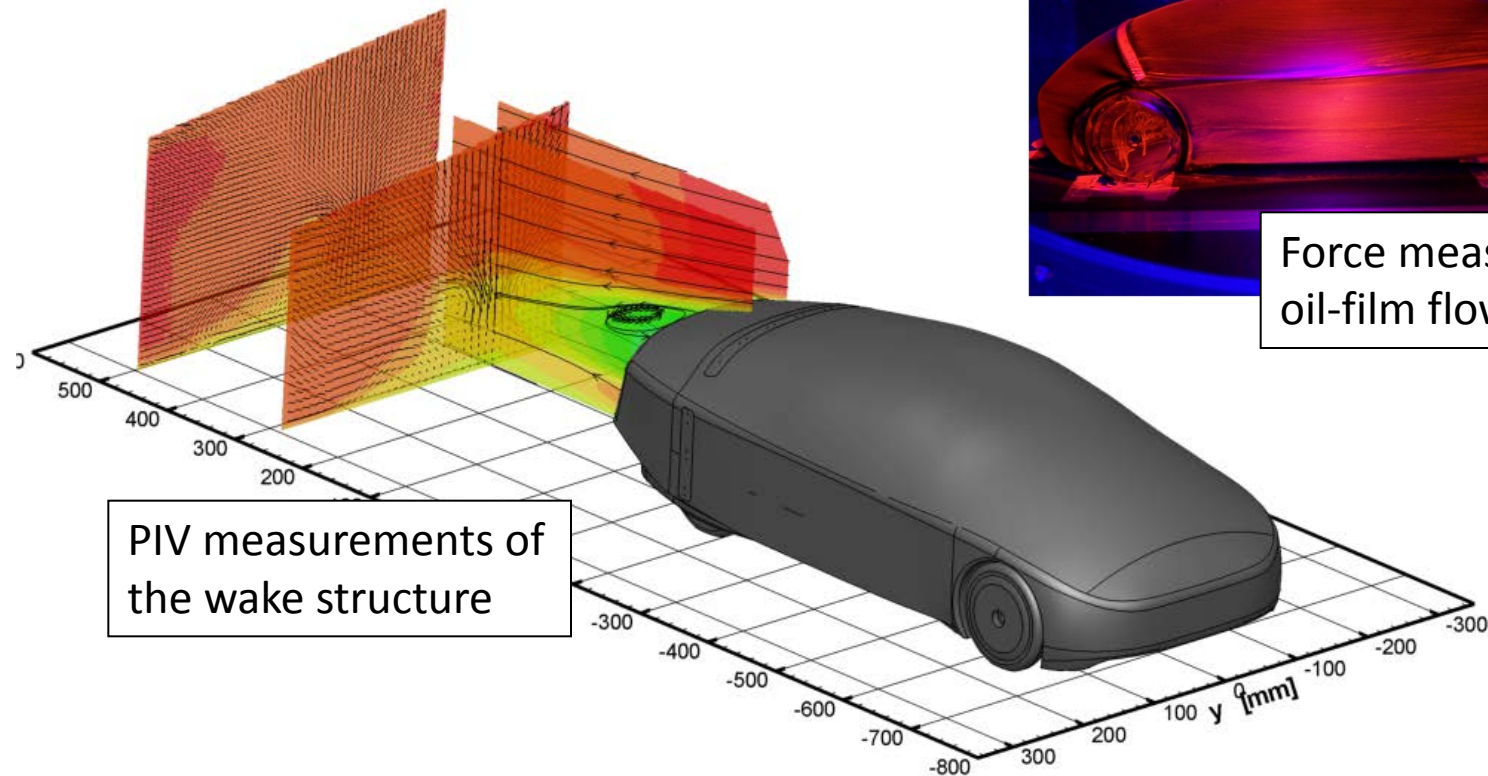

PIV measurements of the wake structure



Force measurements and oil-film flow visualization

PIV Measurements behind the Car

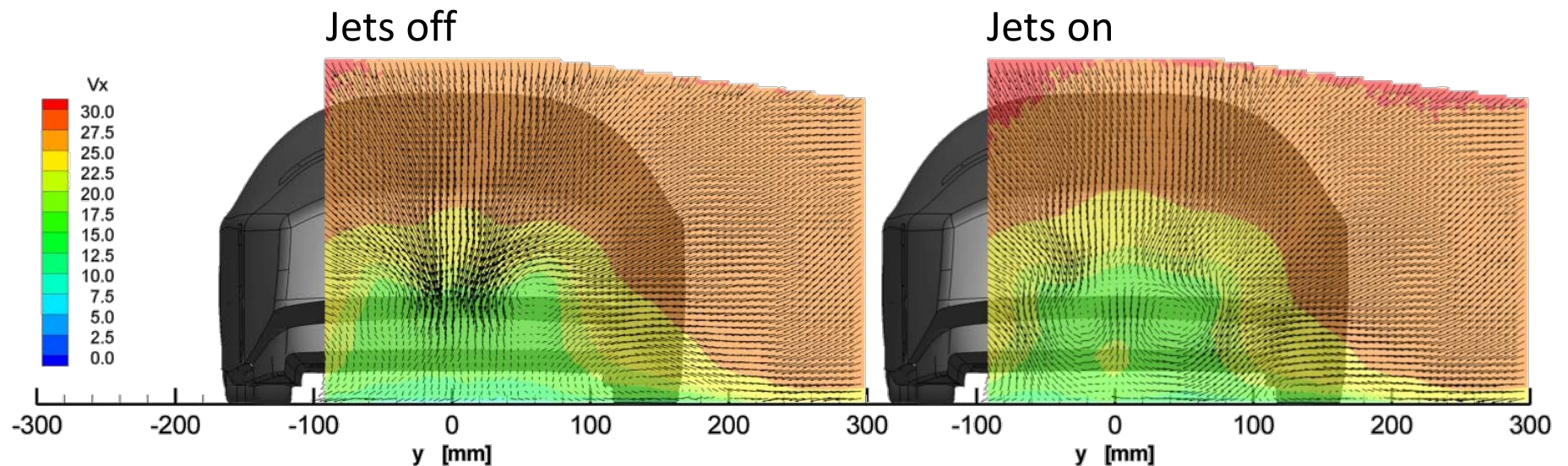

- Much weaker longitudinal vortices
- Significant reduction on rear lift: $0.10 \rightarrow 0.08$
- Measurable effect on drag ($<1\%$), but still too small to be economic

Adjoint-Based Optimization for Cars: Overview

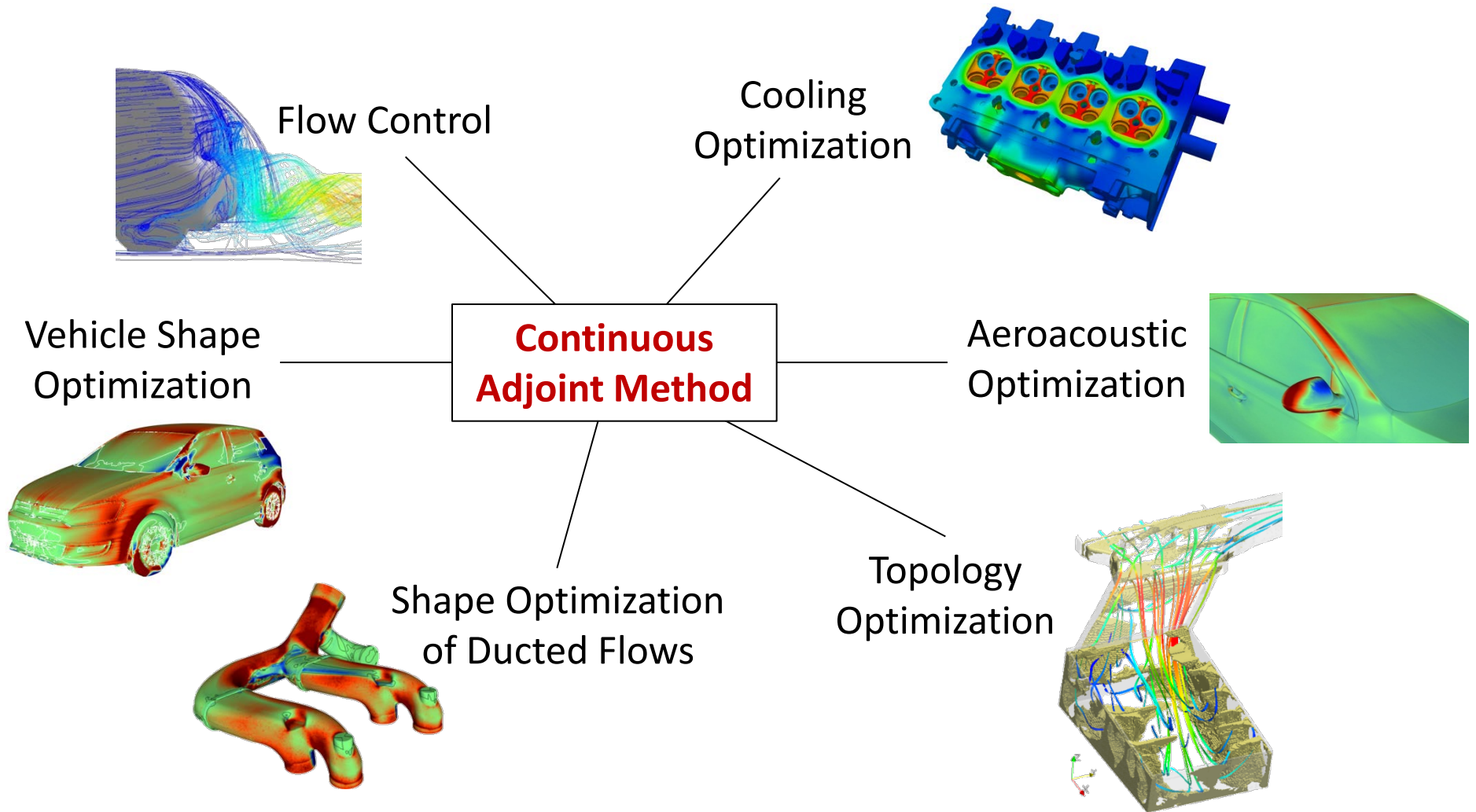

Main Motivation: Cylinder Head Cooling

Solid part of the cylinder head

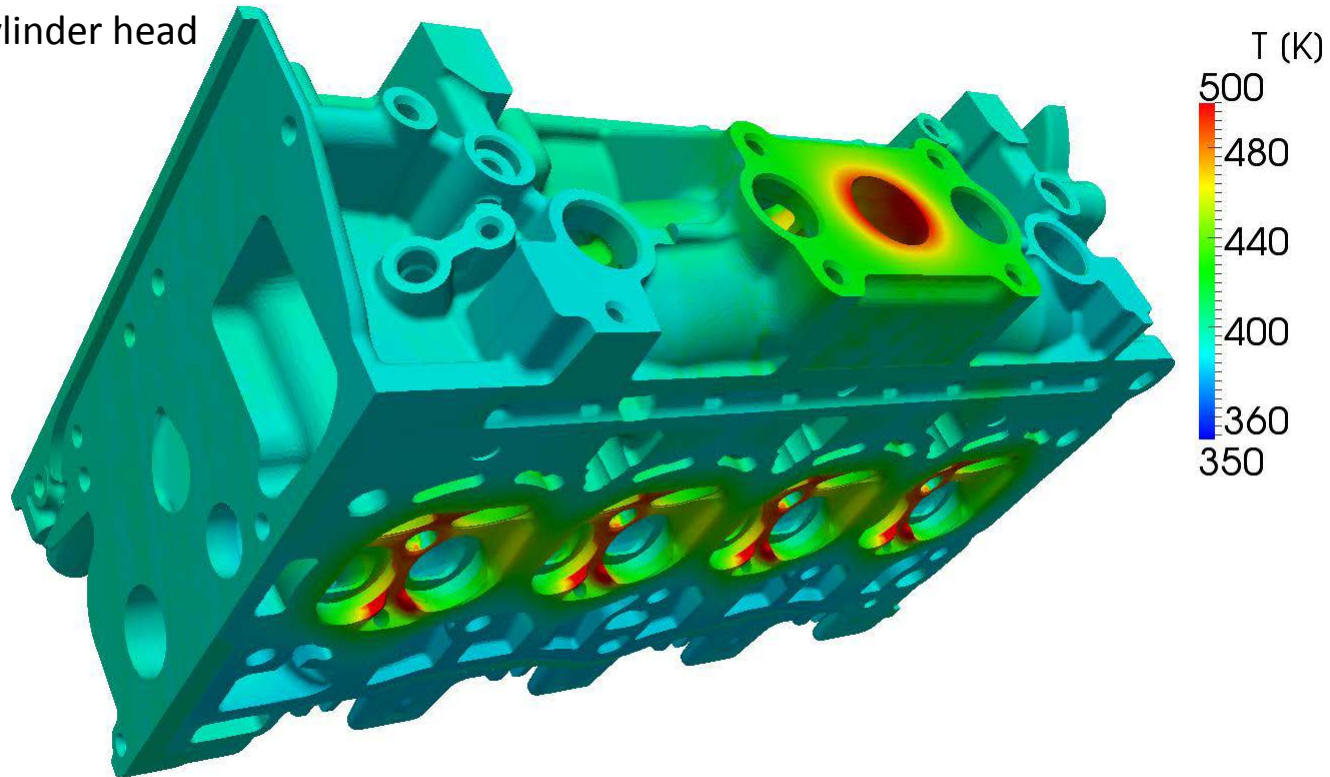

Main Motivation: Cylinder Head Cooling

Fluid volume (“water jacket”)

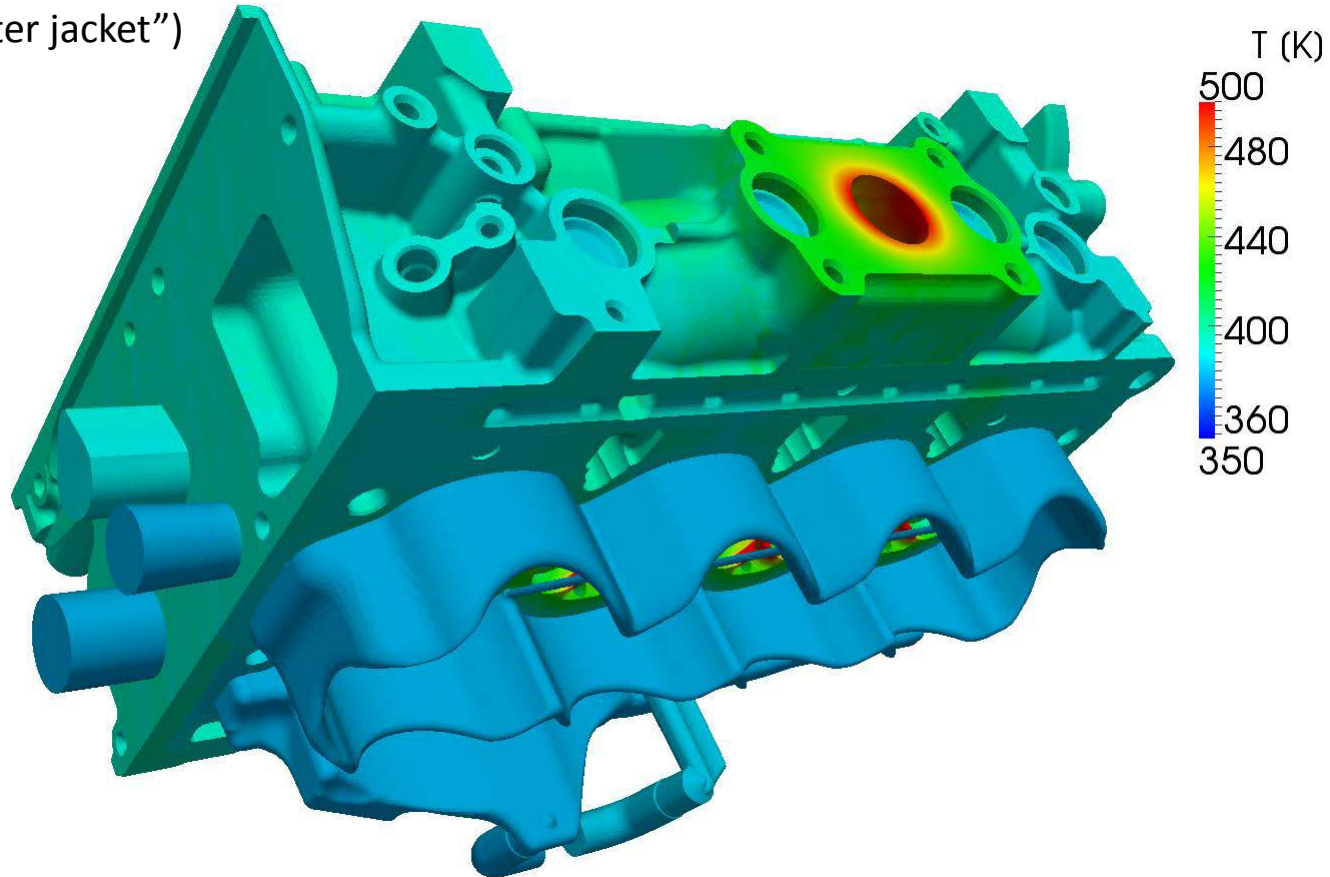

Main Motivation: Cylinder Head Cooling

Streamlines

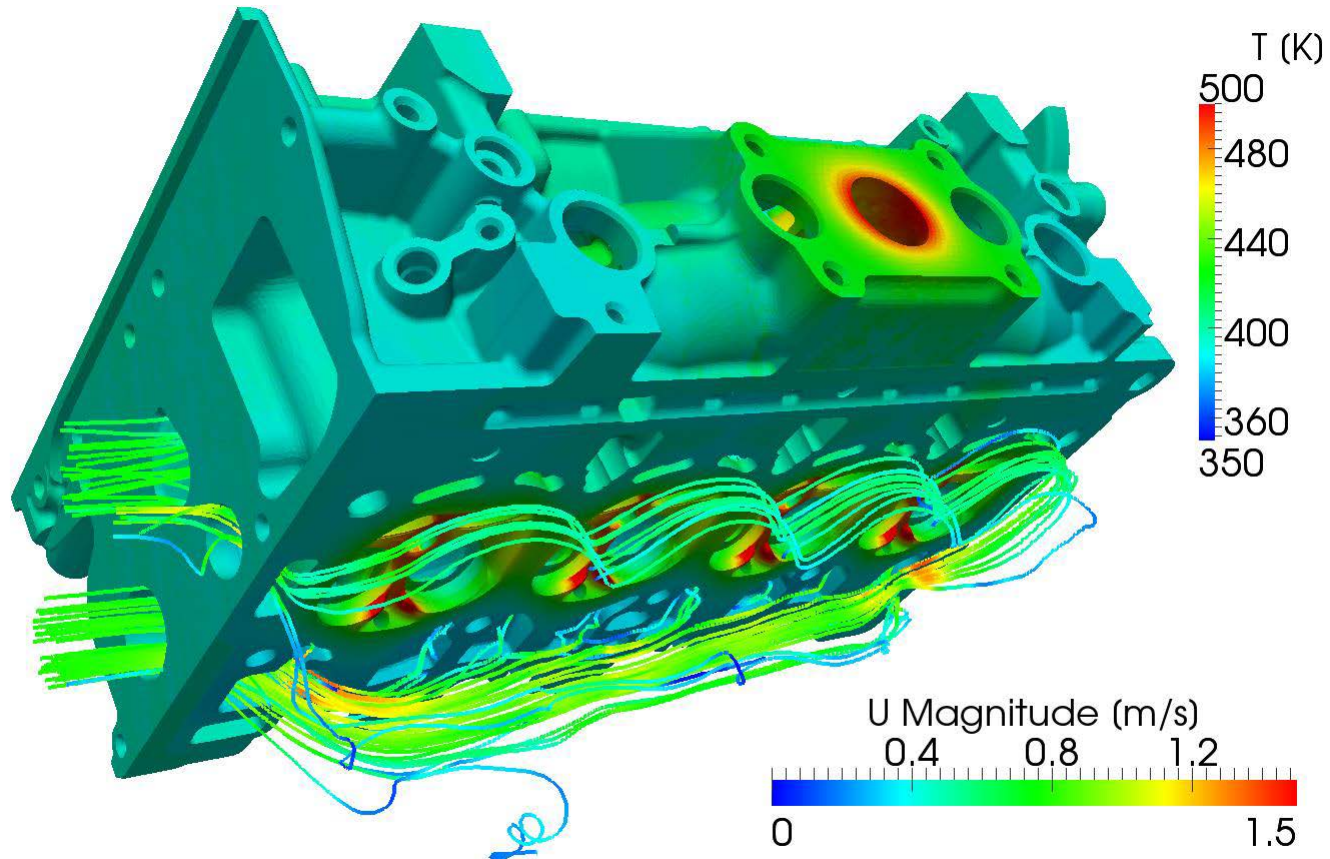

Extension of the Adjoint Solver towards Conjugate Heat Transfer

- Development and validation of an adjoint conjugate heat transfer code (NTU Athens in cooperation with Volkswagen Research)
- Objective function: average T^n in the solid domain
- Design variables: node displacements along the fluid/solid interface
- Test case: square channel

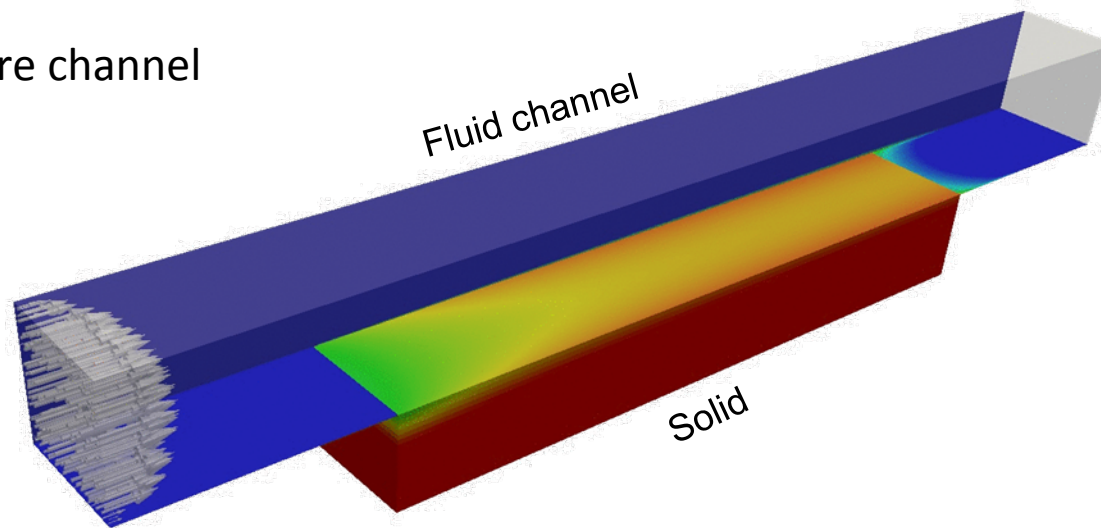

[from H. Narten, VW EA]

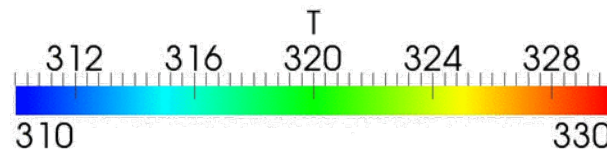

Extension of the Adjoint Solver towards Conjugate Heat Transfer

- Development and validation of an adjoint conjugate heat transfer code (NTU Athens in cooperation with Volkswagen Research)
- Objective function: average T^n in the solid domain
- Design variables: node displacements along the fluid/solid interface
- Test case: square channel

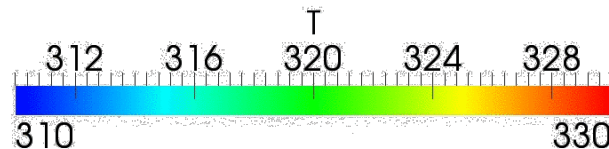
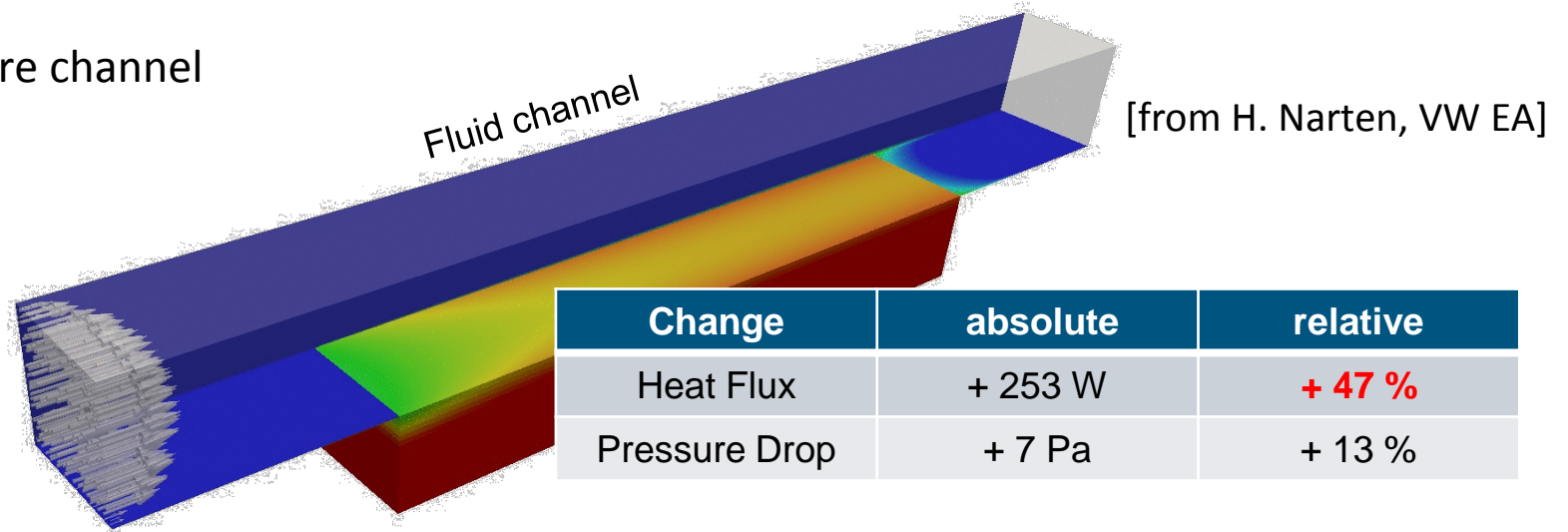

Check 1: Physics or Numerical Noise?

- 10 times higher resolution along the interface
- Result: Deviation of heat flux < 0.5%

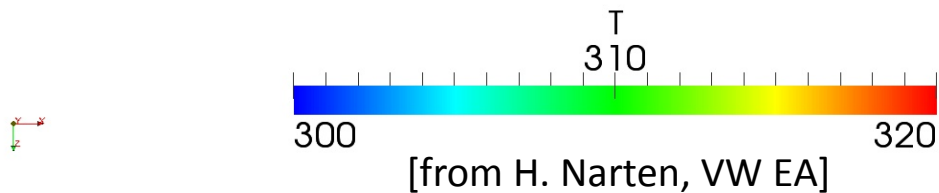
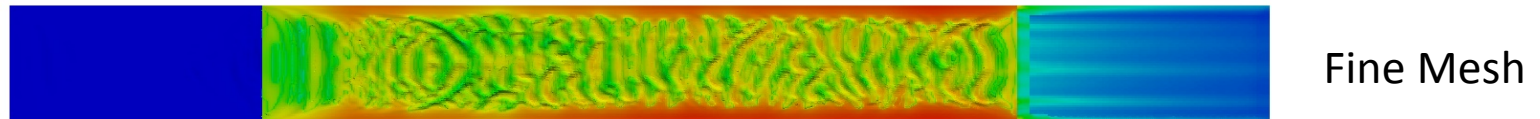
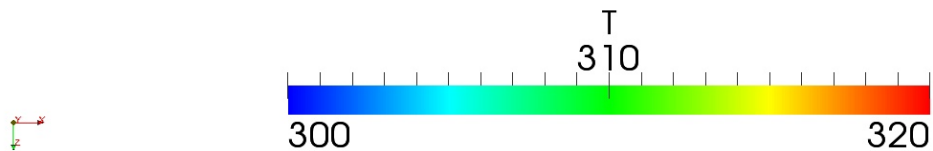
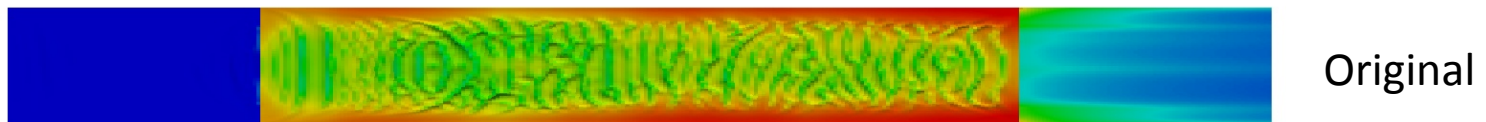

Check 2: Comparison with Sinusoidal Wave Pattern

- Wavelength taken from FFT of optimized interface
- Heat flux significantly lower for sinusoidal waves (-20%)

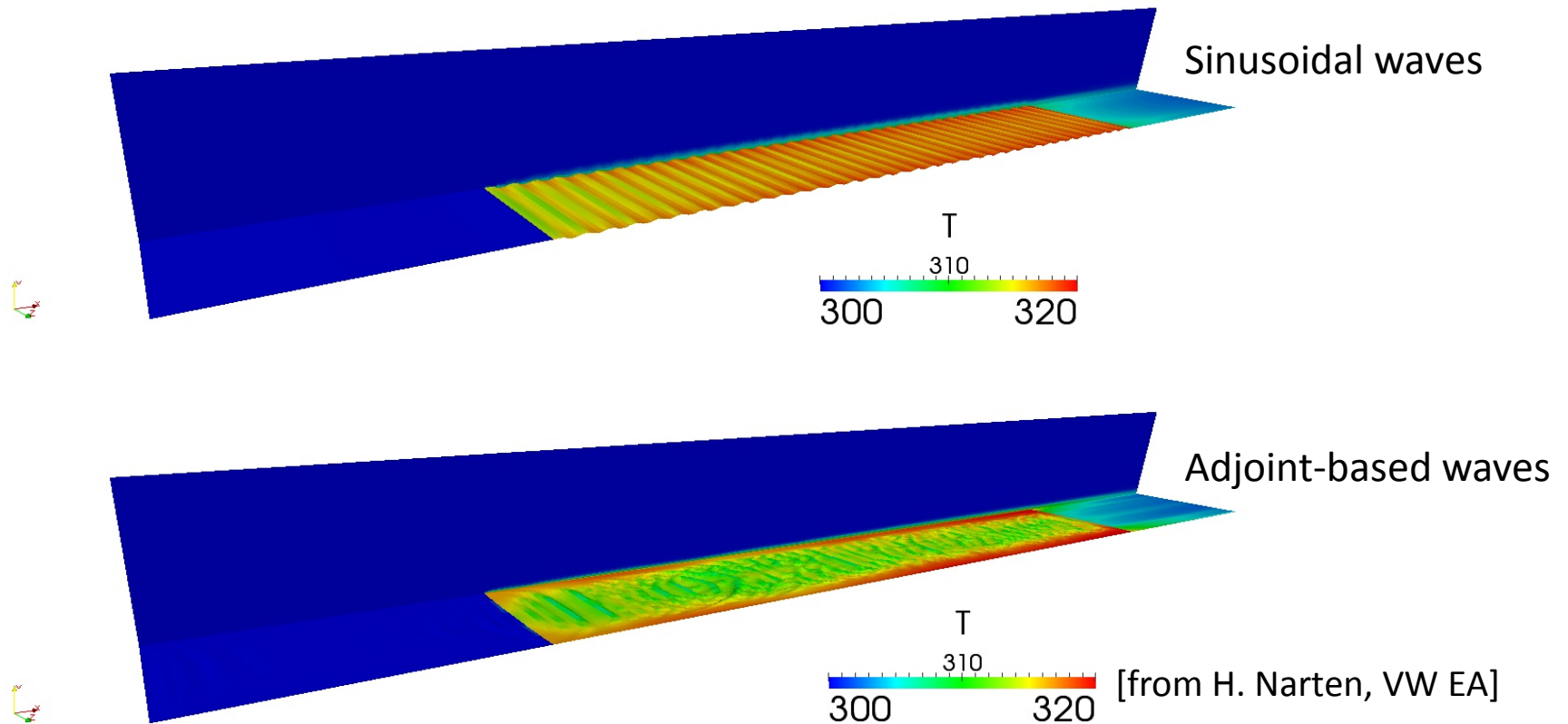

Adjoint-Based Optimization for Cars: Overview

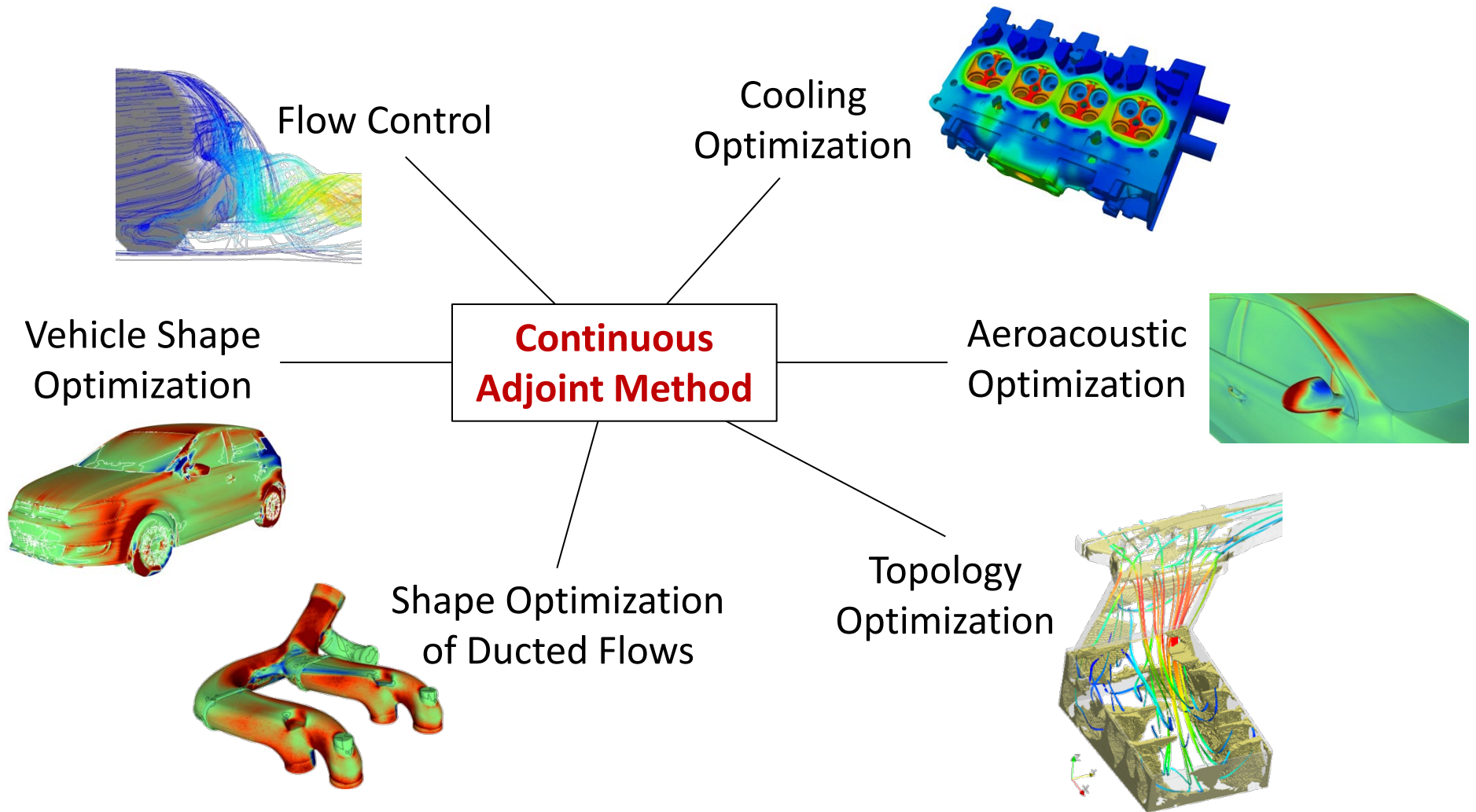

Aeroacoustics: Mirror Noise

RANS

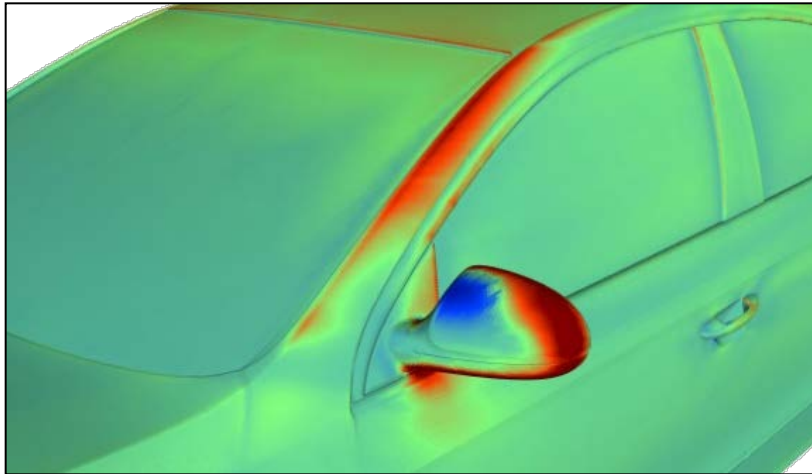

Surrogate cost functions:

- nu_t inside a volume adjacent to the side window
- (wall shear stress)² integrated over the side window

DES [from M. Hartmann, VW Research]

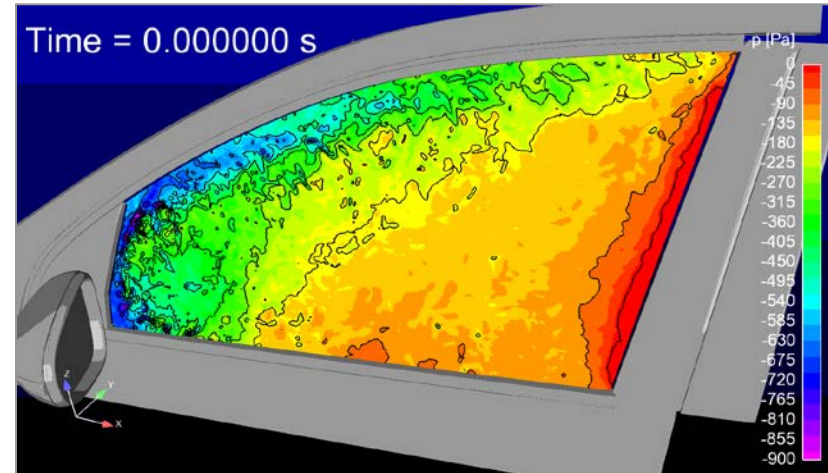

More adequate cost function:

- $J = (p(t) - p_{avg})^2$

Time-varying adjoint source term:

- $\text{div } u = p(t) - p_{avg}$

Towards Unsteady Adjoints: DES Drag Sensitivities

[From N. Magoulas, VW Research]

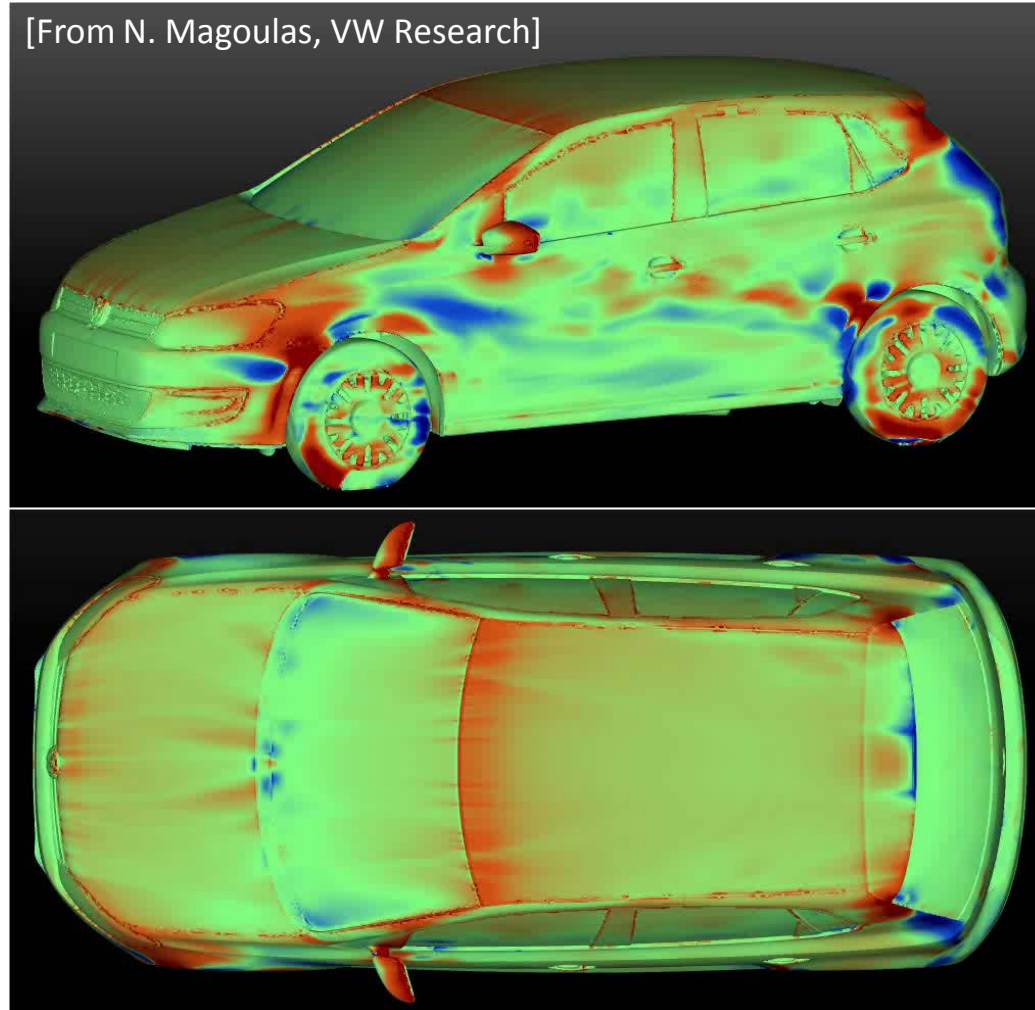

Summary

